

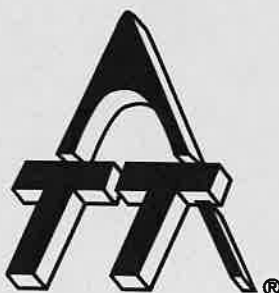

**UNDERGROUND
BORING
TOOL**

***GRUNDOMAT Model - P
Operators & Parts Manual***

Part No. 07076707



TT Technologies, Inc.

Table of Contents

Safety Section

1.	Safety Information about the GRUNDOMAT	4-7
-----------	---	-----

Operations

1.	Introduction to GRUNDOMAT	8
2.	Operation of the GRUNDOMAT	
	Connection to a Compressor	8
	Lubrication Operation and Adjustment	9
	Aligning and Starting the GRUNDOMAT	10
	General Instructions for Operation	11
	The Reversing Mechanism	11
	Factors Affecting Accuracy	12
3.	Attachments	13
4.	Laying of Cables and Pipe	
	Solo Boring	13
	Pipe Pulling	14
	Sleeve Connections	15
	Pipe Replacement	15
5.	Special Applications	
	Vertical boring	15
6.	Preventative Maintenance	16
7.	Threadlocking & Bonding	16

General Maintenance Procedures

1.	Procedures & Equipment	
	Spanner Wrenches	18
	Loctite Thread Sealing	19
	Securing the GRUNDOMAT Using the Repair Stand ...	19
2.	Head Assembly	
	Removal of the Stepped Cone	20
	Removing the Casing Tip	20
	Assembly of the Head Assembly	21
3.	Control Assembly	
	Servicing the Whip Hose (45-110 models)	24
	Control Stud Disassembly (45-110 models)	24
	Control Stud Re-Assembly (45-110 models)	26
	Servicing the Whip Hose (130-180 models)	27
	Control Stud Disassembly (130-180 models)	28
	Control Stud Re-Assembly (130-180 models)	30
4.	Piston	
	Piston Removal All Tools	32
	Piston Assembly All Tools	32
5.	Function Test	
	Check the Piston	33
	Check Operation	33
	Technical Information	33

Part Number Listings

L-6	Appendix	34-42
------------	-----------------------	-------

Important Safety Instructions

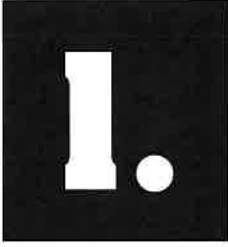

This symbol calls attention to important safety instructions which, if not followed, could result in serious personal injury or death.

Read, understand and observe all safety information and instructions in this manual, and on safety decals on the GRUNDOMAT piercing tool before using it. For safety reasons, read the operators manual carefully and exercise caution while using the GRUNDOMAT piercing tool. Please note specific safety requirements as explained by procedures called out in this manual. Failure to follow these instructions could result in serious personal injury or death.

WARNING



All tools, materials and equipment manufactured and supplied by TT Technologies, Inc. are designed to be used by qualified and trained personnel only. TT Technologies, Inc. will not be held liable for any injury or damage to either people or property resulting from the misuse of TT Technologies equipment.

Please save this user's guide for future reference and have it available to all operating personnel.

Do not start, operate or service machine until you read and understand operator's manual.

Failure to do so could result in serious injury.

CAUTION



WEAR EAR PROTECTION

CAUTION



WEAR SAFETY GLASSES

CAUTION



WEAR SAFETY SHOES

CAUTION



WEAR SAFETY GLOVES

CAUTION



WEAR HARD HAT



DANGER:

DANGER indicates an imminently hazardous situation which, if not avoided, will result in death or serious injury. This signal Word should be used in the most extreme situations.



WARNING:

WARNING indicates a potentially hazardous situation which, if not avoided, could result in death or serious injury.



CAUTION:

CAUTION indicates a potentially hazardous situation which, if not avoided, may result in minor or moderate injury.

SAVE THESE INSTRUCTIONS

GRUNDOMAT is manufactured to the current technical safety-relevant regulations. Nevertheless, the use of the machine may represent a danger to the health and life of users or third parties. Always ensure that you pay particular attention to warnings, safety labels and instructions.

Call Before You Dig!

Check the existence and exact position of buried pipe and cables by contacting the respective utilities or owners of networks. The exact and definite existence and position of buried cables and pipes should be defined by trial pits or using cable and pipe detection equipment or other means.

Cable Strike!

Should you accidentally hit an electrical cable, immediately leave the site, ensure no one enters and contact the electrical company to turn off the supply. In case of a cablestrike, the danger resulting from that damaged electric cable can only be evaluated following detailed information by the respective electrical company. Never rely on your own knowledge as to types of cables, safety measures and protective measure which may not be correct for the type of cable encountered. Always consider cables to be "live" and a potential danger to life. Do not re-enter the site until authorized by the electrical company.

Danger of Entrapment!

Do not place hand in moving machine components or devices. Always ensure that all safety guards, covers or other safety devices are correctly in place "before starting." Do not remove safety covers or safety devices during operation of the machine.

No loose clothes!

Do not wear loose clothes or long hair. Danger of body injury by loose clothes or hair being caught in the moving parts of the machine.

Suspended loads!

Do not stand under suspended (floating) loads. Danger of body injury by falling loads. Use suitable means of avoiding danger.

Disconnecting Air Hoses!

Only disconnect pressure free hoses. Always turn off the compressor and bleed all air before disconnecting hoses. Before starting any maintenance or inspection work, ensure that the GRUNDOMAT is not connected to any air supply. During repair and maintenance operations always follow the respective safety recommendations. Repair and maintenance operations are restricted to trained and certified staff only.

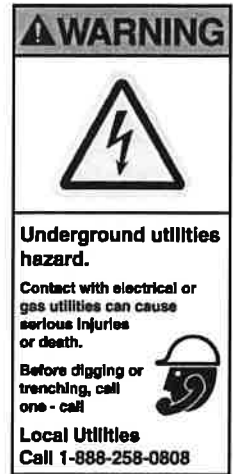

SAVE THESE INSTRUCTIONS

NOTICE



Do NOT operate tool at pressures exceeding 100 psi. Damage to internal components will result.

Do Not Over-Pressurize!

Do not over pressurize, otherwise explosion or serious damage may occur. Do not exceed the operating pressure of 7 bar (100 psi). Make sure to only use original T.T. hoses with T.T. couplings that are suitable for this pressure.

Read Operators Manual!

Before starting the machine, fulfill all safety related requirements. All personnel should thoroughly read this operating manual.

Follow all safety instructions concerning safety and possible danger. Do not modify or remove the safety devices or warning labels of this machine. Keep all labels regarding safety and possible danger on the machine in good, readable condition. Special care is required before and during the safety check.

Every crew member should fully understand the safety measures required for the operation and should be capable of following these regulations individually.

WARNING



Do not start, operate or service machine until you read and understand operator's manual. Failure to do so could result in serious injury.

Safety Equipment!

The operating crew should always wear the appropriate safety equipment, i.e., ear protection, safety shoes/boots, hard hat, safety glasses, gloves etc.

Operation by Qualified Personnel Only!

Operation of the GRUNDOMAT should be carried out by suitably trained, qualified, and certified personnel only. New operators or operators in training should be working under the constant supervision of a qualified person. Personnel operating the GRUNDOMAT should have sufficiently studied the operating manual.

Skin Burning Warning!

This item can be hot or cold. Do not touch as burns may result.

CAUTION



Air Hose and GRUNDOMAT Tool Maintenance!

Never use self-swaged hoses. Swaging, re-fitting or replacement of air hoses should always be done in a specialist workshop only. Make sure that the hose couplings are properly tightened before starting the compressor. Check all hoses, pipe lines, fittings, joints and securing bolts daily for correct position and function before starting the bore. Use the machine only if it is in perfect working order and after studying the operating manual, particularly the safety-related sections. Always check the machine and its accessories for unwanted movements.

WARNING



To guarantee long life, regular maintenance is essential. Inadequate or infrequent repair and maintenance operations may lead to accidents, downtime and costly repairs of the machine.

Transporting the GRUNDOMAT Tool!

Danger of accidents. The downward movement of the piston may lead to the GRUNDOMAT slipping through the textile sling or (in case of smaller machines) through the operator's hand. Never lift or carry the machine using the air hose (whip hose)—damage to the hose may result. Handling and transporting the machine should be done on a flat, level surface only. Do not overload the transportation vehicle.

SAVE THESE INSTRUCTIONS

Unitherm Setup!

Adjust the UNITHERM so that the compressed air does not exceed a temperature of 100°C. Make sure to follow the safety aspects mentioned in the UNITHERM operating manual. Improper use may cause an explosion. ***Never connect the UNITHERM and the combined control unit/lubricator in line.***

Using a Starting Cradle & Entrance & Exit Pit Excavation!

It is recommended that the GRUNDOMAT P be used with the starting cradle for correct alignment. Do not touch the steel cable. Do not re-tension during operation. In case of boring above or below known utilities (electrical, gas, water, telecom or others) make sure that a starting cradle is used to align the machine onto the target point. Secure the starting cradle so that the front is the length of the GRUNDOMAT head assembly away from the front wall. The walls of the starting pit should be made vertical where the machine enters. If the soil in the starting pit is very soft and loose, then the cradle should be supported on wooden boards, fixed timber or other means. Always ensure that no buried services are beneath the starting cradle in the launch pit otherwise you may drive an earth anchor into them & cause serious damage.

Make sure there is a sufficient amount of ground cover.

Make sure that start and exit pits are excavated and shored as necessary to comply with OSHA regulations and guard against collapse.

Operation of the GRUNDOMAT Tool!

Start operation of the GRUNDOMAT on reduced air (pressure) only. Always run the GRUNDOMAT slowly into the ground, continually checking the line and level with the GRUNDOSCOPE. Only when satisfied that all is correct should the GRUNDOMAT have full power from the compressor by fully opening the ball valve. Check the GRUNDOSCOPE for accuracy before each bore.

The control unit/lubricator, should always be within reach of the operator.

In case of danger to people or machine, turn off the air supply from the compressor immediately. Always watch the behavior and reaction of your colleagues. In case of danger, take the necessary steps immediately.

Use recommended oils and lubricants only.

Firmly hold or block the hose end when cleaning the hose with compressed air. Point the hose away from body. Do not point hoses at others.

Respect a minimum safety distance from any over head live lines.

When operating beneath railroad tracks, all standards and requirements should be observed. Machine and equipment should be removed from a job site on the track-free side. Never cross the tracks unless supervised.

SAVE THESE INSTRUCTIONS

Introduction to GRUNDOMAT

1.

The GRUNDOMAT boring tool is a cylindrical air-hammer which is driven through the ground by compressed air. Its bores (ranging up to 7⁷/₈-in. or 200-mm.) are used for the laying of pipes and cables under roadways and other surface installations.

The GRUNDOMAT can be used in all displaceable soils (sand, loam, gravel)—even those soils containing fracturable rocks. The GRUNDOMAT, however, cannot be used in solid rock, and is not designed for use against unfracturable rocks. Also, soft soils (as in a swamp) may present problems in accuracy as the tool's own weight may cause it to deviate.

In normal operation, however, the patented reciprocating stepped cone chisel head and long cylindrical shape ensure maximum boring accuracy. Normally, when a boring tool encounters a rock, the tool is pushed off course. The reciprocating action of the GRUNDOMAT, however, will break a rock up and allow the tool to pass. In addition, if the tool should encounter an unfracturable rock, the GRUNDOMAT can easily be reversed and retrieved to re-start the bore.

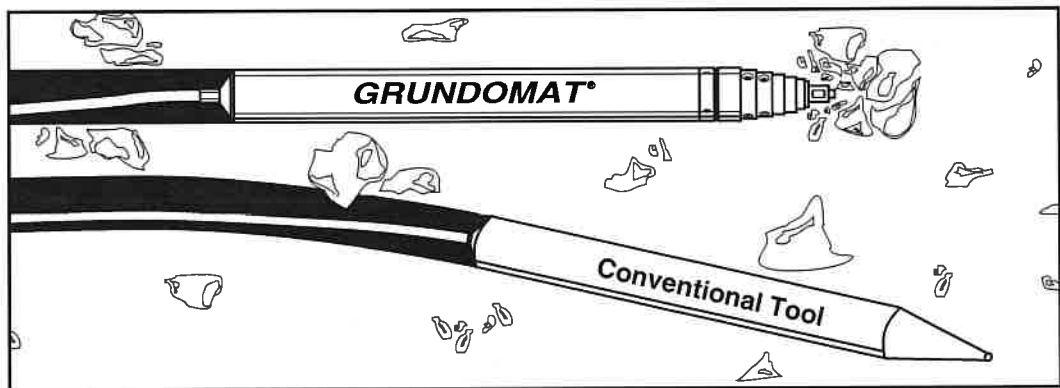

FIG 1: THE GRUNDOMAT

Operation of the GRUNDOMAT

2.

Connection to a Compressor

Like any pneumatic tool, GRUNDOMAT requires a compressor with adequate capacity for optimal operation. Please see the technical data (page 33) to determine the quantity of air required for each individual GRUNDOMAT model. Note that the operating pressure must not exceed 100 psi.* **Operating the GRUNDOMAT at pressures higher than 100 psi will invalidate the warranty.**

Before connecting the GRUNDOMAT blow air through the air hoses to remove any dirt or other contamination.

**As a rule of thumb, there is a 5 psi drop in air pressure per 50 ft. length of hose. Adjust regulator accordingly.*

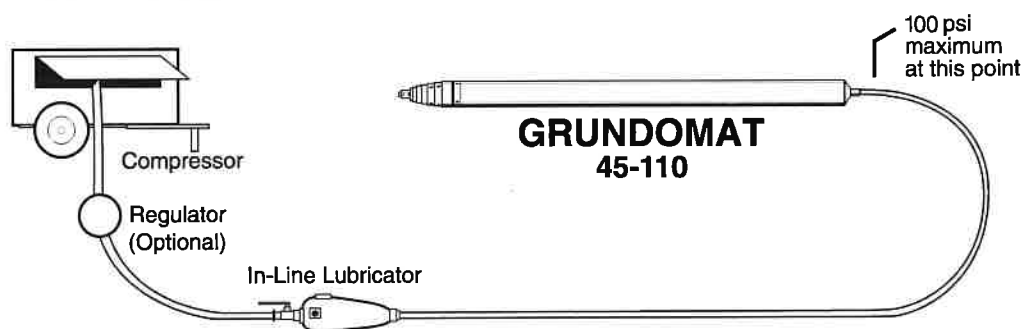
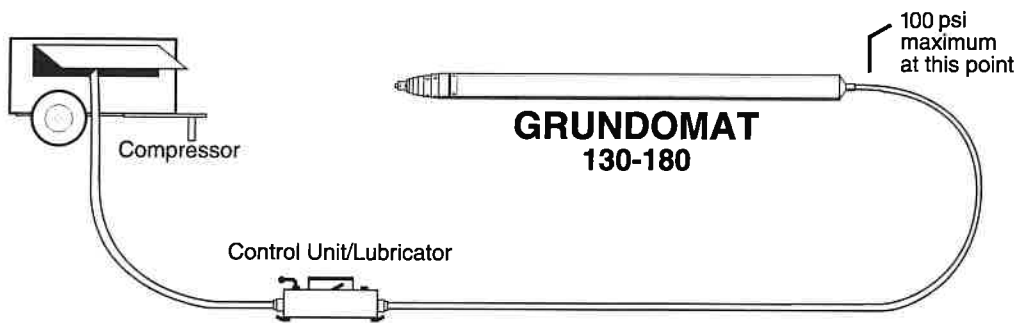

FIG. 2: TYPICAL GRUNDOMAT CONNECTION SEQUENCE
MODELS 45-110



**FIG. 3: TYPICAL GRUNDOMAT CONNECTION SEQUENCE
MODELS 130-180**

Make sure that the couplings are securely interlocked and safety rings are tightened before the machine is started. Wrap the couplings with adhesive or electrical tape to keep dirt from getting into the air line.

GRUNDOMAT requires continuous lubrication during operation. This is provided by the in-line lubricator, which is connected between the regulator and the tool. The lubricator should be checked daily at least to ensure that it contains an adequate supply of oil.

Lubricator Operation and Adjustment

High quality pneumatic lubricant is essential for optimum performance of the GRUNDOMAT soil displacement hammer. GRUNDO-OIL is the recommended lubricant and in addition, GRUNDO-OIL prevents water vapor from freezing inside the machine. GRUNDO-OIL is completely safe, biodegradable and has no harmful effect on rubber air hoses.

The lubricator ensures that the necessary lubricant is vaporized and supplied to the GRUNDOMAT. If using the silver ASL lubricator the quantity of oil delivered to the GRUNDOMAT can be adjusted by turning the metering screw that is located in the oil reservoir under the fill cap. Normal setting for these lubricators is 3 to 4. During operation of the GRUNDOMAT a small mist of GRUNDO-OIL should be seen in the exhaust air coming out of the hammer. The red button on the filler cap should be depressed to relieve reservoir pressure and preventing oil discharge when the bore is completed.

When using the blue pot style lubricator the quantity of oil can be varied by turning the adjustment knob in one of five settings on top of the lubricator. During transport the adjusting knob should be in the zero position.

The following chart list control knob settings and oil consumption quantities for the different GRUNDOMAT models.

GRUNDOMAT (mm)	Knob Position	Oil Consumption/Hour
65	3	3.5 - 7 oz
75	3	3.5 - 7 oz
85	3	7 - 10 oz
95	2-3	7 - 10 oz
100	2-3	7 - 10 oz
110	2-3	10 - 13 oz
130	2	17 - 20 oz
145	2	20 - 23 oz
160	2	20 - 23 oz
180	1-2	20 - 23 oz

NOTE: Due to differences in oil compositions, other types of lubricating oils should not be used for the GRUNDOMAT. Some oils may attack and destroy seals in the tool.

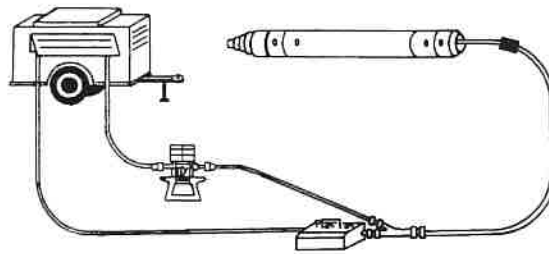

FIG. 4: SET UP WITH THE UNITHERM COMPRESSED-AIR HEATER



During operation, the compressed air expands in the GRUNDOMAT causing the machine to cool down. Under certain conditions, especially in cold temperature, the machine may cool down so much that the water in the air may form an ice coating on the GRUNDOMAT. An ice coat will bring the GRUNDOMAT to a standstill, even at full impact power. This is avoided by using a Unitherm compressed air heater to heat the air before it enters the tool.

IMPORTANT: The GRUNDOMAT requires more oil as the air temperature rises. Increase lubrication by removing filler cap on the lubricator and adjusting the brass control screw.

Aligning and Starting The GRUNDOMAT

Once the GRUNDOMAT is in the ground, it runs straight; its direction cannot be changed or corrected (similar to a bullet when fired from a rifle). For this reason it is extremely important to align the GRUNDOMAT exactly on target. This can be accomplished using several methods: bottom trench launching with a lever using GRUNDOSCOPE and surveyor's stake or using a starting cradle and anchor stakes with the larger GRUNDOMATS.



FIG. 5: THE STARTING CRADLE

DANGER: Before starting the bore, the utility one call number must be contacted so that any utility lines can be located and marked in the area. Always bore from the congested utility area to the non-congested area.

NOTE: The minimum depth specification for operation of the GRUNDOMAT is ten times the tool diameter. If the minimum depth is not observed, there is a risk of surface damage from soil displacement (see Fig. 6).

The starting and exit pits should be excavated, with the pits being back sloped or shored to conform with local safety work codes. For small diameter bores, the GRUNDOMAT is laid in the bottom of the pit and pointed at the exit pit. A level is used to set the level or grade. When a precise bore is needed then a GRUNDOSCOPE is placed on the GRUNDOMAT. With the height setting of the GRUNDOSCOPE noted on the surveyor's staff, a line of sight is taken and the GRUNDOMAT is positioned to align it to the point of exit. Once the GRUNDOMAT is aligned, it should be run into the ground at reduced power (by opening the ball valve half way or less) until the GRUNDOMAT is one third of its way into the ground. Stop and check the alignment making corrections at this time. Until the GRUNDOMAT is fully into the bore, its line and grade should be constantly checked and where necessary, corrected. It may be necessary to stop the GRUNDOMAT several times. The accuracy to the bore is entirely dependent on correct starting alignment. After the GRUNDOMAT is half way into the ground and the alignment and grade are correct then the air flow can be increased slowly to full power.

Larger diameter bores may require a starting cradle to assist alignment of critical bores. A starting cradle is a guide device that provides for exact aligning of grade and direction. It can be used with the GRUNDOSCOPE for a complete alignment system.

To use the starting cradle, position it with the roller toward the starting pit wall. Lower the GRUNDOMAT onto the starting cradle so that the front one third of the tool is centered on the cradle. The anchor stakes are next driven into place to fix the cradle to the pit floor. While using the GRUNDOSCOPE the starting cradle can be adjusted both vertically and horizontally with the adjusting screws until the crosshairs in the scope line up with the designated mark on the surveyors staff. Operate and check for alignment as described earlier.

WARNING	
Underground utilities hazard.	
Contact with electrical or gas utilities can cause serious injuries or death.	
Before digging or trenching, call one - call	
Local Utilities Call 1-888-258-0808	

The working depth should be at least 10 times the GRUNDOMAT diameter.

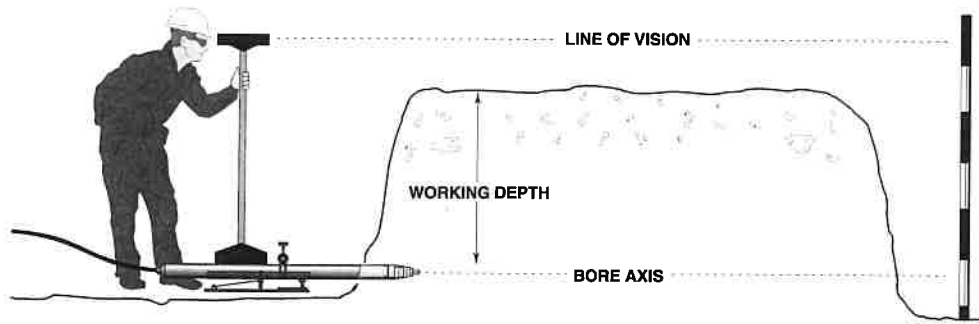

**FIG. 6: WORKING DEPTH OF GRUNDOMAT &
FIG. 7: ALIGNING THE GRUNDOMAT WITH THE AIMING FRAME.**

General Instructions to be followed during Operation

Always keep a close eye on the GRUNDOMAT while it is working. If the GRUNDOMAT is boring faster than 60-ft. per hour decrease the air supply. The GRUNDOMAT may go off course at that rate of speed.

If the GRUNDOMAT does not begin to cycle when the machine is started it may require an alternate starting procedure. One of the following may be used:

- Turn off the air supply and wait for pressure to bleed out of the tool. Then open valve completely to start the tool.
- Switch from forward to reverse under normal air pressure.
- “Kick-start” with a surge of air pressure. This can be accomplished by kinking the air hose (as close to the tool as possible), turning on the air and then releasing the hose.
- A quantity of TT TECHNOLOGIES lubricating oil or biodegradable lubricant (about 4 oz.) can be introduced into the tool by pouring it into the air hose. Then reconnect the hose and try again.

If the hose is shaking or rapidly cycling back and forth in the starting pit the GRUNDOMAT may be swimming in the bore. Reduce the air supply to the GRUNDOMAT to allow the soil to grip the sides of the casing and allow forward progress to continue. When boring in unstable ground (sand, loose gravel) it is recommended to pull pipe behind the tool.

It is recommended that the air hose be marked at regular intervals as an aid to determine the distance that the GRUNDOMAT has covered. Remember to add the lengths of the tool and connection hose itself to these calculations.

As the GRUNDOMAT emerges into the exit pit, reduce the air supply.

The Reversing Mechanism

The GRUNDOMAT can be reversed if it encounters an unfracturable obstacle or if it is used for making dead-end holes.

When reversing, the operator should firmly hold the hose and make sure that the tool does not back over it.

IMPORTANT: Do not attempt to reverse the tool when the pipe-pulling tailpiece is attached unless the pipe is also in place. Reverse direction should only be attempted with reverse cone in place or when pipe pulling tailpiece and pipe are in place.



NOTICE

Tool Reverse

- Switch from forward to reverse under normal air pressure. Do NOT turn air pressure off.
- To kick tool into reverse, grasp supply air hose and turn counter clockwise 1/4 turn.
- While tool is reversing, operator should pull back air hose to keep tool from backing over and choking off air supply.

Do not attempt to reverse the tool when the pipe-pulling tailpiece is attached unless the pipe is also in place.

Reversing the tool

Model	Air Supply	Procedure
45-110P	on	While air supply is on, turn air hose in a counter-clockwise direction, 1/4 turn (Control stud will move back 2-in) Release hose.
130-180P	on	Move handle from forward to reverse on the control unit/lubricator.

Re-setting for forward motion

Model	Air Supply	Procedure
45-110P	off	After air supply is shut off, turn hose 1/4 turn counter-clockwise (Control stud will move forward 2-in) Release hose.
130-180P	on	Move handle from reverse to forward on the control unit/lubricator.

Factors Affecting Accuracy

Although the GRUNDOMAT is extremely accurate under most conditions, there are several factors which can affect the accuracy of a bore.

Soft soil

If the soil is too soft or watery, the machine will tend to slip slightly due to its weight and/or vibration. Some counter measures include:

- attach a pipe pulling kit and pull pipe
- reduce compressed air supply by 50%
- assist the pipe pulling procedure by using a continuous winch and double locking clamp (see Fig 12)
- push the pipe (steel) using the pipe pushing attachment

In dry conditions the minimum depth should be increased as much as possible to reduce the chance of surface disruption.

Insufficient boring depth

If the boring depth is insufficient, the GRUNDOMAT might tend to deviate upwards. Counter measure: increase the working depth. Although the minimum working depth is 10 times the GRUNDOMAT diameter, in dry conditions the depth should be increased as much as possible to reduce the risk of surface damage.

Worn displacement cone

A worn displacement cone will cause a loss of accuracy. Inspect the cone before making the bore. If the steps are badly worn, replace the cone (see Fig. 8 & 9).

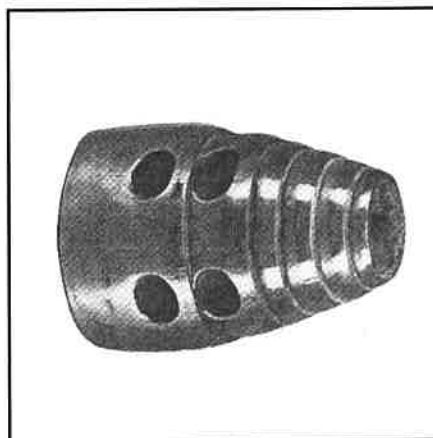

FIG. 8: BADLY WORN STEPPED CONE

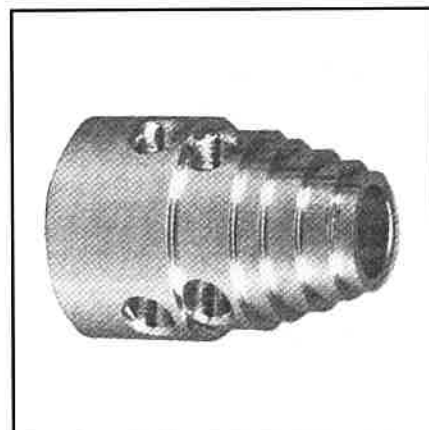

FIG. 9: NEW STEPPED CONE

Attachments

Front-end attachments include: expanders, pulling attachments, smooth cones, oversized multicutter cones and pipe driving and ramming adapters (see Fig. 10).

Some soils, especially clay-like soils, may create excessive friction on the tool casing, “gripping” the casing and slowing the tool down. To compensate for this condition, an oversized cutter cone is recommended. This attachment will reduce the “grip” of the soil on the casing and should increase speed.

Expanders effectively increase the outside diameter of your GRUNDOMAT, enabling you (under many circumstances) to make larger diameter bores—without the expense of having to purchase a larger boring tool (see Fig. 10).

In sandy soil conditions a smooth cone may be attached to the GRUNDOMAT for a faster bore. It must be stressed, however, that this may affect the accuracy of the bore. It is generally best to prioritize accuracy of the bore over speed.

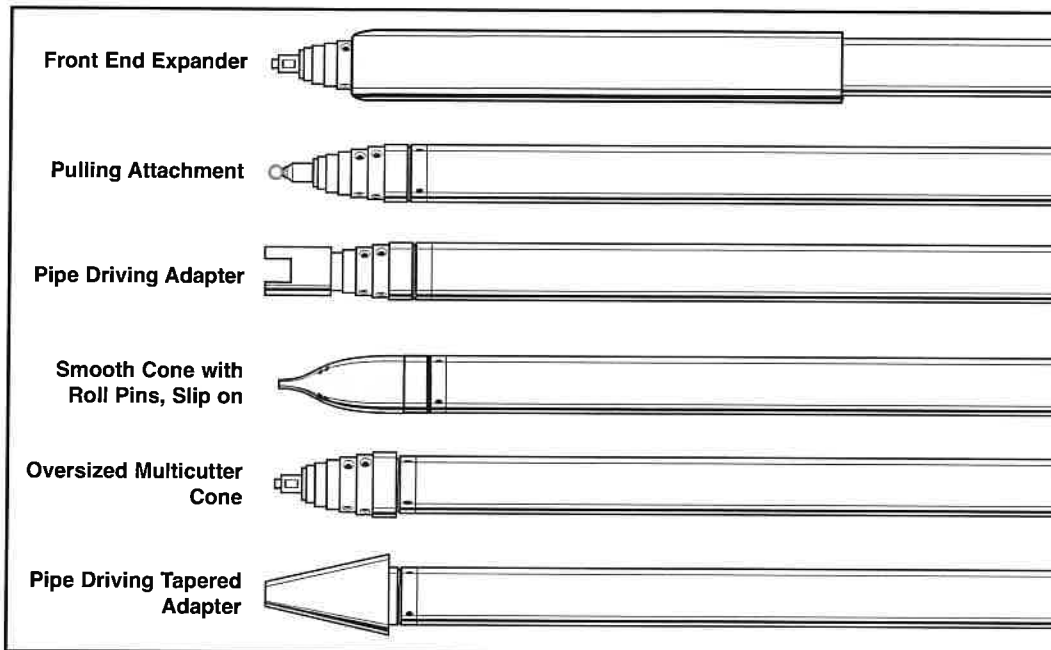

FIG. 10: ASSORTED FRONT-END ATTACHMENTS

There are a multitude of other accessories available for use with the GRUNDOMAT boring tool designed to accomplish specific tasks. Contact your GRUNDOMAT dealer for further information. Additionally, TT TECHNOLOGIES is staffed with an experienced engineering department and machine shop and is available to help you with any problems you may have pertaining to specific job applications. One-time products have been produced to enable our customers to overcome particular job-site problems.

Laying of cables and pipes

Solo Boring

Knowing that the soil will not collapse into the bore, the two-step “solo-bore” procedure can be used; installing the pipe or cable after the bore is made. When the tool has completely cleared the borehole, disconnect the air hose and attach an air hose pulling eye (see illustration at right). Attach a rope or cable that can be pulled in as the air hose is removed. Use a cable grip or PE pipe pulling nipple to attach the final product to the rope/cable. Pull in final product. This method of boring is frequently used for the small GRUNDOMAT models or for short distance runs.



Pipe Pulling

For operation with the larger GRUNDOMAT models, for covering longer distances, and for soils which tend to collapse after the bore, it is best to pull the pipe directly behind the tool while boring.

Pipe pulling is accomplished with a pipe pulling tailpiece, which fits onto the rear of the GRUNDOMAT, replacing the rear cone assembly. Pipe pulling tailpieces come in a diverse range of diameters for many sizes of pipe. Pipe pulling also requires the use of a pulling clamp, and may require other accessories as well, like a PE pipe cutting nipple, depending on the size and type of pipe being pulled.

Begin by inserting the air hose and pulling cable inside one or more sections of the pipe. (Taping the hose and pulling cable together makes this process much easier.) Although it is not necessary to attach all the pipe sections at first, it will avoid having to stop and add them during the bore.

Connect the hose and pulling cable to the tool and push the pipe into the tailpiece. Then connect the pipe pulling clamp to the rear of the pipe, snug the clamp firmly against the pipe and clamping the cable. For most situations, a plain pipe pulling clamp will provide the necessary pulling force (see Fig. 11).

When using non-PVC pipe with GRUNDOMAT tools 5-in. or larger, (or if the soil is highly unstable), additional rear pressure must be applied to the pipe to assist the tool. In this case a double locking pipe pulling clamp is used instead of the ordinary clamp. This is used in combination with a pulling winch and steel cable (see Fig. 12).

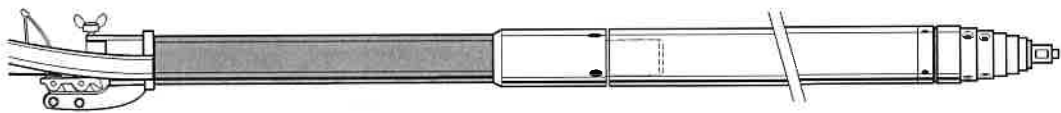

FIG. 11: PLASTIC PIPE PULLING CLAMP

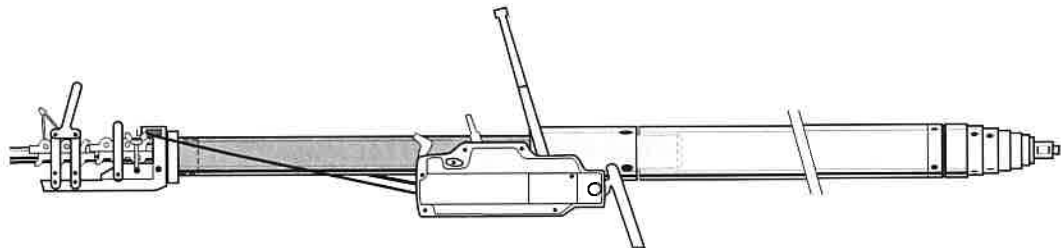

FIG. 12: CONTINUOUS WINCH WITH DOUBLE LOCKING CLAMP

The procedure for pulling pipe using the pulley clamp is the same as with the plain clamp except for these additional steps:

- Attach the pulling winch to the starting cradle, and thread the steel cable around the double locking clamp. Then fasten the spring set to the other side of the starting cradle and attach the cable to the springs. During the bore, apply continuous pressure to the pipe with the winch.
- Make sure that the connections at the pipe pulling clamp are always firm so that the pulling cable cannot slip.
- The shock absorber is another accessory that is used for pulling in fitted steel pipe 5-in. to 7-in. in diameter.

Sleeve Connections

Pipes with internally and externally smooth surfaces are highly recommended. The maximum outside diameter of the pipe to be laid (i.e. pipe diameter with the coupling) should be about 10-15% smaller than the boring diameter (see Fig. 13).

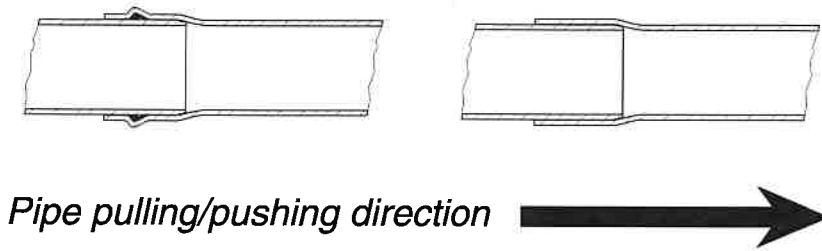
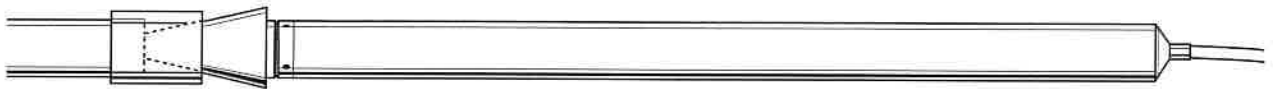

FIG. 13: SLEEVE CONNECTIONS

Steel-Pipe Pushing

When fitted with a special pipe-driving adapter, the GRUNDOMAT (models 375 and larger) is capable of pushing pipe instead of pulling it behind the tool (see illustration below). Contact your GRUNDOMAT dealer for more information on this application.



Pipe Replacement

In a single operation, old pipe can be pushed out while pulling new pipe in (see Fig. 14).

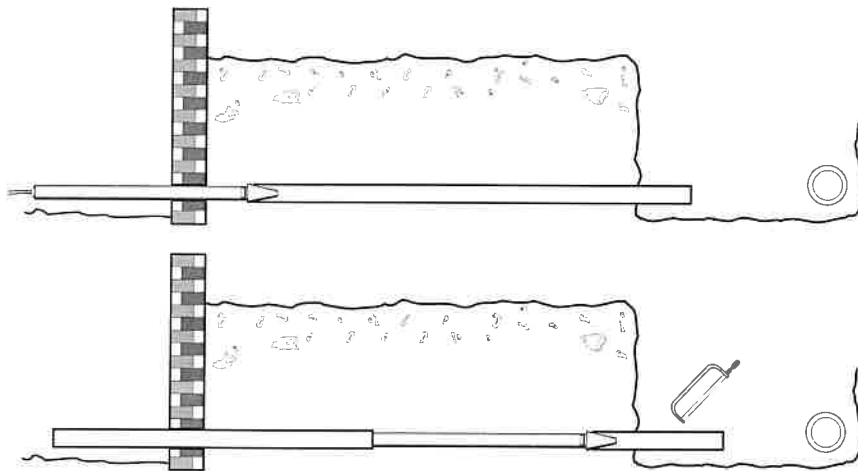

FIG. 14: OLD STEEL PIPE OUT, NEW PIPE IN

Special Applications

Vertical Boring

The GRUNDOMAT along with a vertical bore stand, can make vertical bores up to 33 feet deep.

5.

Preventative Maintenance

6.

The tool should be flushed with air tool oil after each usage, and again before any period of extended storage. This helps prevent premature failure of the teflon seals. After approximately 400 work hours you should inspect and replace seals as needed, check to make sure that the stepped-cone is attached securely, and check the strength of the head spring. Remove the control stud assembly for cleaning and for checking the reverse control, piston, and seals. Also check the control unit/lubricator for wear.

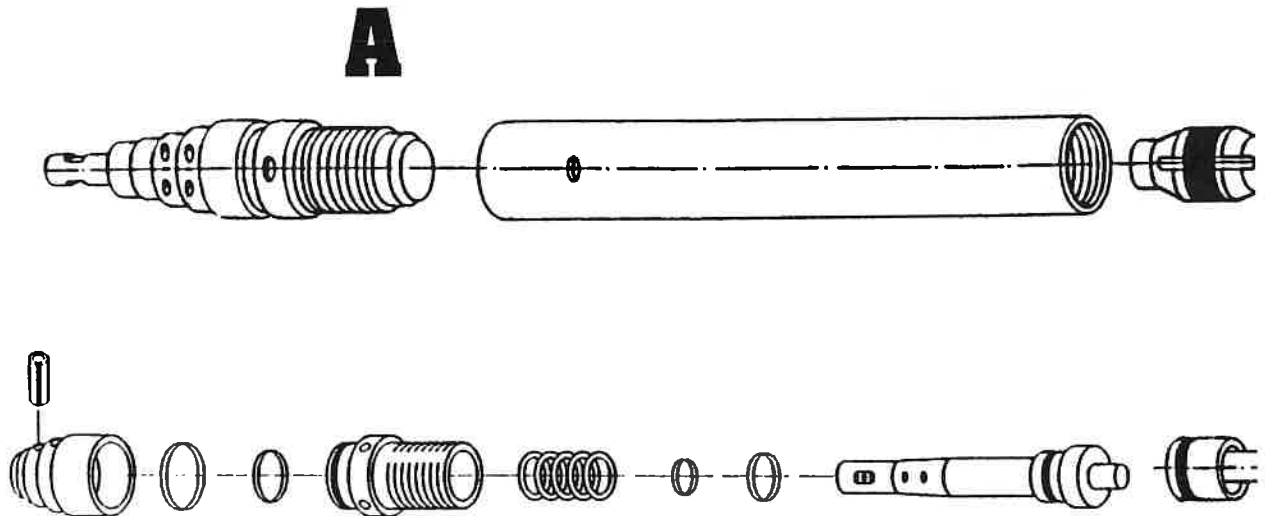

Threadlocking & Bonding

7.

The recommended procedures for obtaining optimum threadlocking and bonding are as follows:

Stepped Head Assembly & Control Stud Housing (Section A & B)

- The parts to be bonded should be carefully cleaned. Debris can be removed with a wire brush. It should then be washed in a cleaner/degreasing solvent and left to dry.
- The threads of the nut (internal thread) is sprayed with the recommended primer and left for approximately one minute to dry. (Internal and External threads are sprayed with primer).
- Correct Loctite product is applied in a zig-zag form across the threads*.
- The activated component is then screwed slowly onto the other component, occasionally backing off with a backwards and forwards motion movement to ensure even distribution of the adhesive across thread faces. The space between the thread flanks must be entirely filled. There should be no air gaps left between the threads.

Reverse Cone, or Pipe Pulling Tailpiece (Section C)

- Teflon pipe tape or PST 567 is applied on the last 10 threads of the reverse cone, pipe pulling tailpiece.

* Reference chart at right.

General Maintenance Procedures

There are four main sections of the GRUNDOMAT maintenance manual:

- 1.** General maintenance procedures & equipment
- 2.** Head assembly
- 3.** Control Assembly
- 4.** Piston

MAINTENANCE

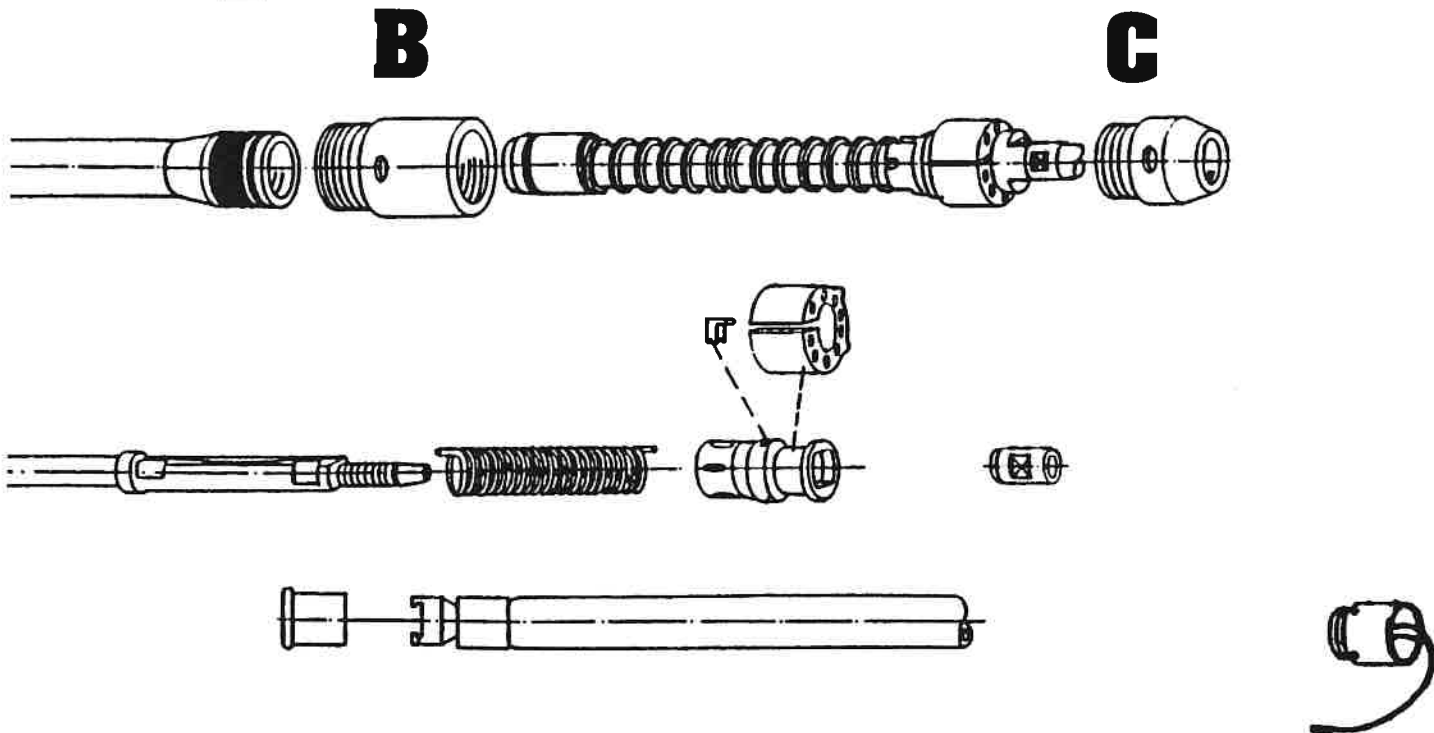

Thread Sealant Usage Chart For GRUNDOMAT*

GRUNDOMAT Model	45	55	65	75	85	95	100	110	130	145	160	180
GRUNDOMAT Size (In)	1.75	2.00	2.50	3.00	3.33	3.75	4.00	4.25	5.00	5.75	6.25	7.00
Section A **	Horizontal lines					Vertical lines						
Section B	Horizontal lines					Vertical lines						
Section C	Cross-hatch					Diagonal lines						

**K
E
Y**

 Loctite® Threadlocker® 638

 Epoxy

 Liquid Teflon® pipe tape or PST sealant 567

 Loctite Speed Bonder™ 277 & primer N.

* Loctite, Threadlocker, Speedbonder and PST are registered trademarks of Loctite Corporation
Teflon is a registered trademark of E.I. DuPont de Nemours Co., Inc.

** Reference drawing above

Procedures & Equipment



The GRUNDOMAT uses a combination of teflon seals, rubber o-rings and teflon slide tapes for the effective sealing and channeling of air pressure during operation. The teflon seals and slide tapes also serve as wear points for many of the moving parts of the tool, greatly enhancing tool life. In order to maintain full pneumatic power and reduce potential wear on the tool, the seals and slide tapes should be inspected and replaced as needed approximately every 400 operating hours.

Spanner Wrenches

GRUNDOMAT operates at very high impact levels, requiring a high level of torque on all the thread closures to keep them from loosening during operation. This high thread torque is accomplished with special spanner wrenches (see Fig. 15), used in combination with a large hammer. A set of these special wrenches is available for each size of GRUNDOMAT. The spanner wrenches fit into indentations on the tool body.

Clean the spanner hole in the casing to avoid deformation of the casing! The shank screw of the spanner should not touch the casing at the bottom of the spanner hole.

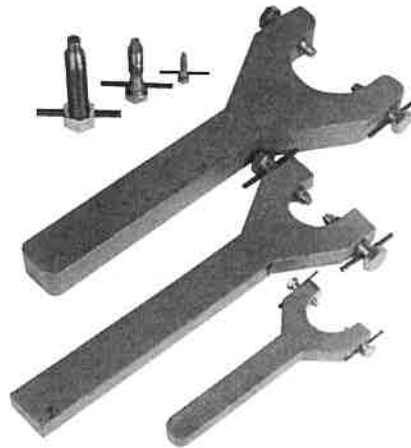

FIG. 15: SPANNER WRENCHES

The spanner wrenches are used in combination with a large hammer to apply a high degree of torque to the threads on the head assembly, control assembly, and reverse cone (or pipe-pulling tailpiece). They are used for both the assembly and disassembly of the GRUNDOMAT (see Fig. 16).

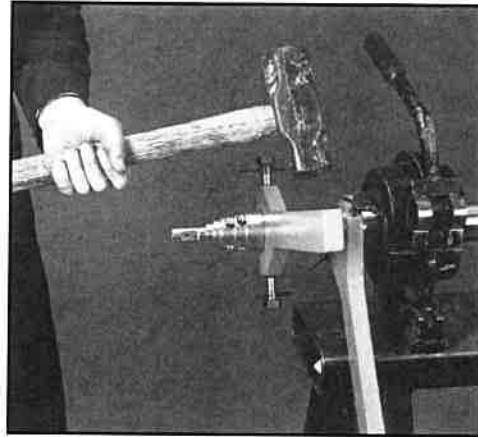
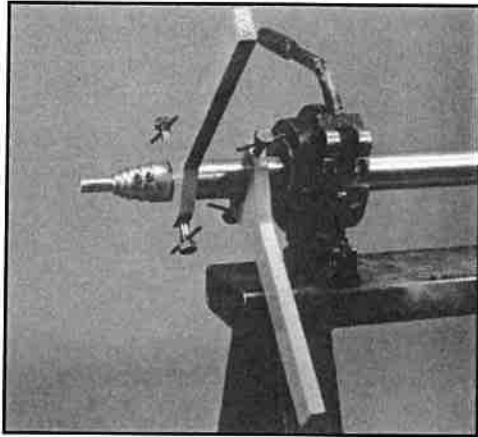

FIG. 16: SPANNER FITTINGS & HAMMER ON SPANNER



Loctite Thread Sealing

The head cone assembly of the tool is sealed with a liquid bonding agent. When trying to break this seal, it may be necessary to heat the outside of the casing to liquefy the loctite. Use a blowtorch or other heat source set at a low flame setting and heat the tool casing evenly to 400°F. (see Fig. 17) Because of the risk of damage to the elastic block, **no heat should be applied to the reverse cone or pipe pulling tailpiece.**

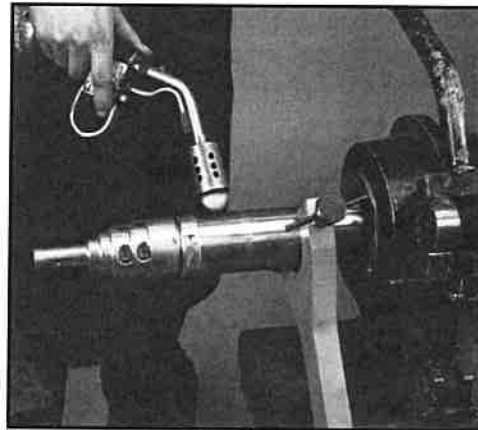

FIG. 17: LIQUEFYING LOCTITE



Heat can be easily monitored with the use of a temperature sensitive crayon.

Securing the GRUNDOMAT

Since it will be necessary to apply a great deal of torque to loosen and remove the front and rear assemblies the GRUNDOMAT should be immobilized as effectively as possible. A special repair stand for the GRUNDOMAT is available from TT TECHNOLOGIES (see Fig. 18). The best practice for stabilizing the machine to apply sufficient torque is the use of spanner wrenches in combination with a large hammer (see Fig. 19).

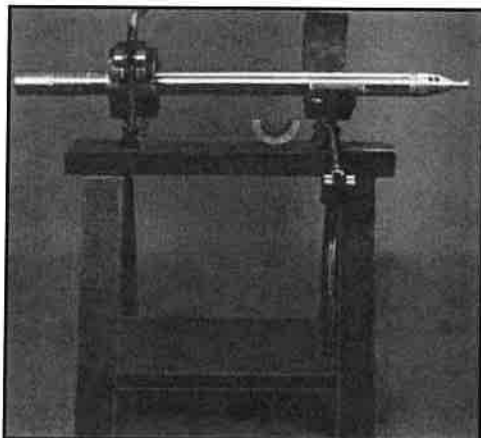

FIG. 18: TT TECHNOLOGIES REPAIR STAND

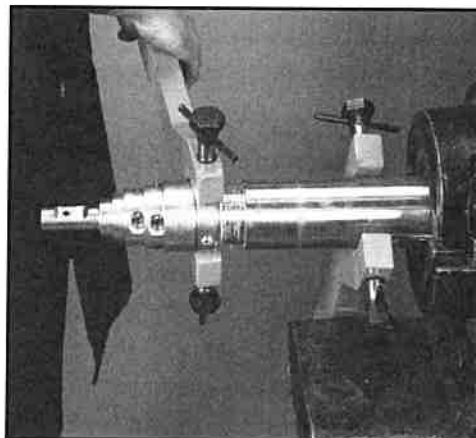

FIG. 19: SPANNER COMBINATIONS

Head Assembly

2.

MAINTENANCE

Removal of the stepped-cone

1. Secure the tool the repair stand.
2. Remove the roll pins with a roll pin punch and a hammer (see Fig. 20).
3. Pull off the stepped-cone.

If the stepped cone does not come off the chisel after removing the roll pins, follow these steps.

4. Run the GRUNDOMAT tool in forward a couple of impact strokes.
5. Position the removal ring on the V-groove between the stepped cone and casing tip. Firmly screw the 3 lock screws into the V-groove (see Fig. 21).
6. Position an impact arbor on the chisel head and give it several heavy blows (see Fig. 22).
7. Retighten the removal ring screws after each series of blows.
8. If the cone still does not come off, it should be quickly heated to approximately 400 degrees F and the arbor given heavy blows once again.

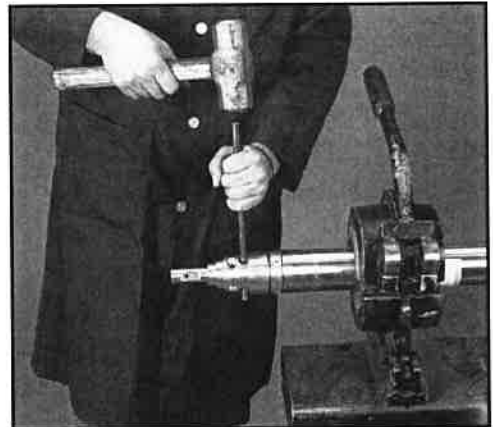

FIG. 20: REMOVING THE ROLL PINS

When using a stepped-cone removal ring, do not stand in front of the tool. It is possible that the stepped cone could abruptly fly off and cause injury.

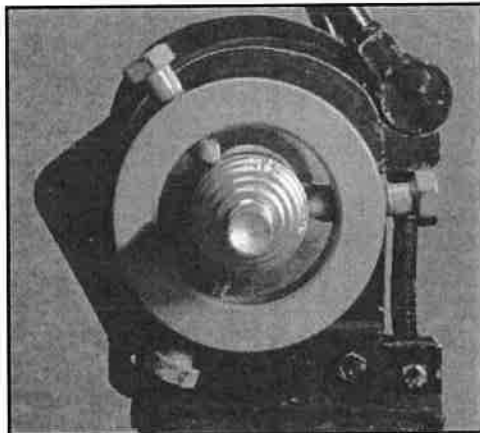

FIG. 21: REMOVAL RING

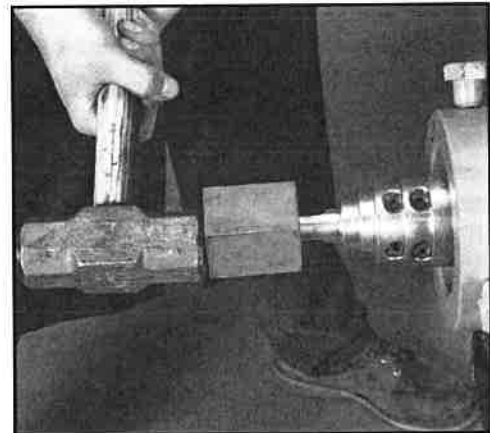

FIG. 22: IMPACT ARBOR

CAUTION



CAUTION: When using a stepped-cone removal ring, do not stand in front of the tool. It is possible that the stepped cone could abruptly fly off and cause injury.

Stepped cone removal rings and impact arbors are available for every size GRUNDOMAT.

Removing the casing tip

After removing the stepped-cone:

1. Attach a spanner wrench to the casing to block the GRUNDOMAT tool from moving.
2. Quickly heat the casing to 400° F to liquefy the Loctite.
3. Loosen the casing tip with another spanner wrench and unscrew the casing tip out of the casing by hand (see Fig 23).

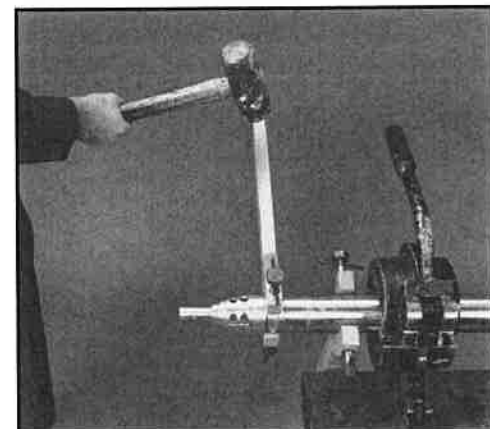

FIG. 23: UNSCREWING THE FRONT CASING AND CHISEL

Assembly of head assembly

1. Remove the chisel, inspect seals for wear. If worn, cut seals and o-ring to remove.
2. Clean the external threads on the casing tip and the internal threads on the casing with a wire brush.

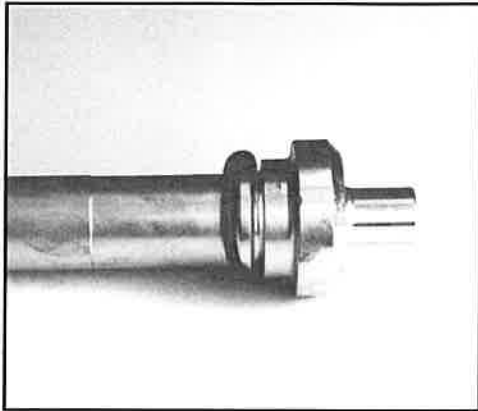

FIG. 24: INSTALL O-RING

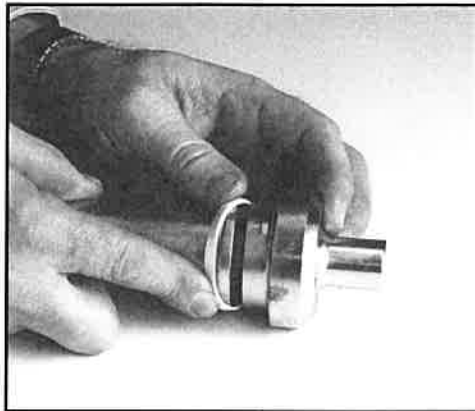

FIG. 25: SLIDE CHISEL SEAL ONTO CHISEL

3. Clean all the threads with a solvent degreaser.
4. Install the o-ring into the groove near the back of the chisel (see Fig. 24).
5. Slide the chisel seal onto the chisel and cover the o-ring (see Fig. 25).
6. Grease the chisel where the spring will be located.
7. Push the spring onto the chisel. Make certain that the chamfered end of the spring is placed against the base of the chisel (see Fig. 26).
8. Insert the chisel into the casing tip (see Fig. 27).

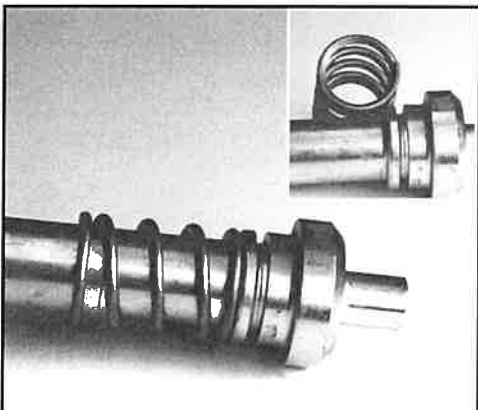

FIG. 26: PUSH SPRING ONTO CHISEL



FIG. 27: INSERT THE CHISEL

9. Install the o-ring(s) into the groove near the front of the casing tip (see Fig. 28).

NOTE: The number of O-Rings under the cone seal depends on the GRUNDOMAT size:

Tool Size	O-Rings	Tool Size	O-Rings
45	0	100.....	2
55	1	110.....	1
65	1	130.....	3
75	1	145.....	1
85	1	160.....	1
95	2	180.....	1

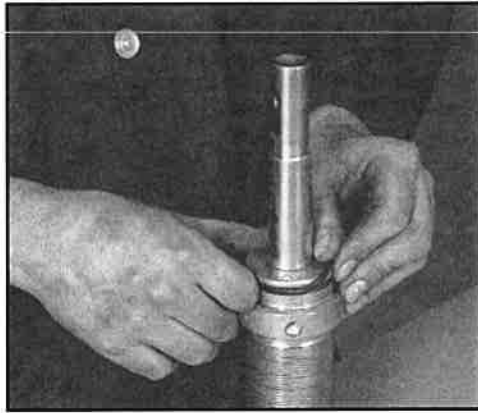

FIG. 28: INSERT O-RINGS

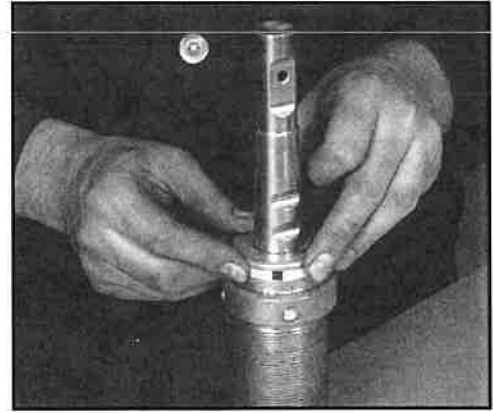

FIG. 29: INSTALL CONE SEAL

10. Install the split cone seal on top of the o-ring(s) and press into the groove (see Fig. 29).
11. Apply grease to the cone seal (see Fig. 30).
12. Screw the casing tip into the casing. Screw on until it bottoms out, but do not lock it in place.
13. Push the stepped-cone onto the chisel. Make sure that the holes in the stepped-cone line up with the roll pin grooves on the chisel. A piece of pipe and hammer may be needed to drive the stepped-cone on properly (see Fig. 31).

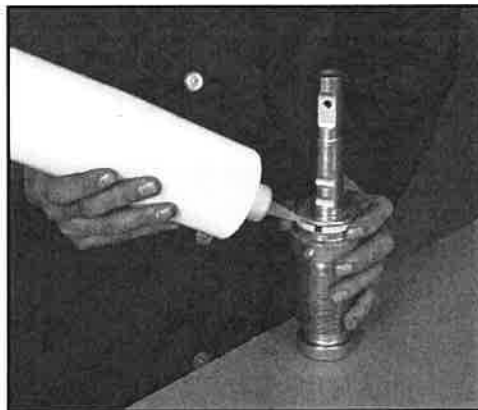

FIG. 30: GREASE THE SEAL

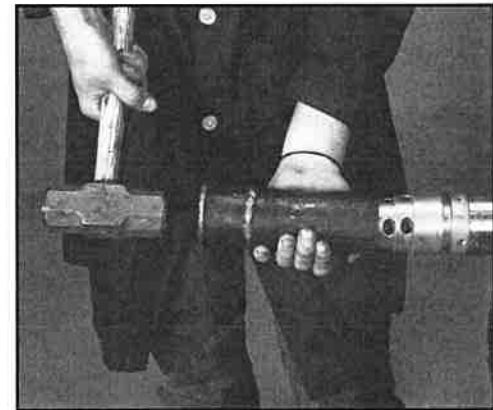

FIG. 31: USING PIPE TO SECURE STEPPED CONE

14. Drive in the larger roll pins first with the split side towards the outside, short ones in front, longer ones in rear (see Fig. 32).
15. Drive in the smaller roll pins, placed inside the larger ones, with the split side towards the inside, short ones in front, longer ones in rear (see Fig. 33).

Never re-use old roll pins; replace them with new ones.

NOTE: Never re-use old roll pins; replace them with new ones!

16. Unscrew casing tip assembly.
17. For all tools apply activator N or T spray onto the threads and let dry for 1 minute.
18. Apply Loctite in a zig-zag fashion over the length of the threads on the casing tip (see Fig. 34).
19. Apply Loctite in a zig-zag fashion onto the first half of the internal threads of the casing.
20. Re-install the tip assembly and complete tightening with several heavy blows (see Fig. 35).

NOTE: When reassembling the GRUNDOMAT, be sure that the serial number on the casing is always positioned at the rear of the tool.

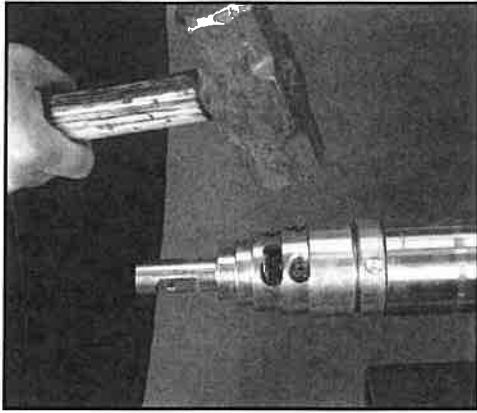

FIG. 32: DRIVE IN THE OUTER ROLL PINS

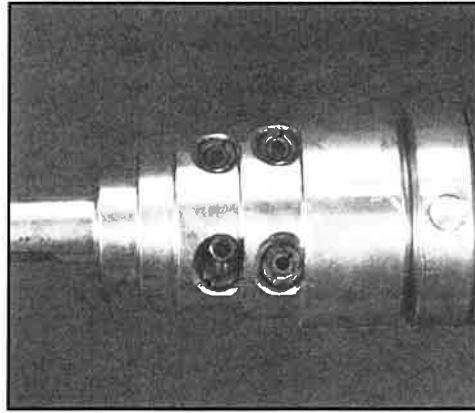

FIG. 33: DRIVE IN THE INNER ROLL PINS

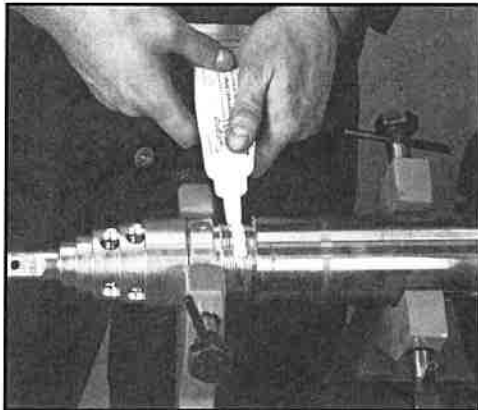

FIG. 34: APPLY LOCTITE TO THREADS

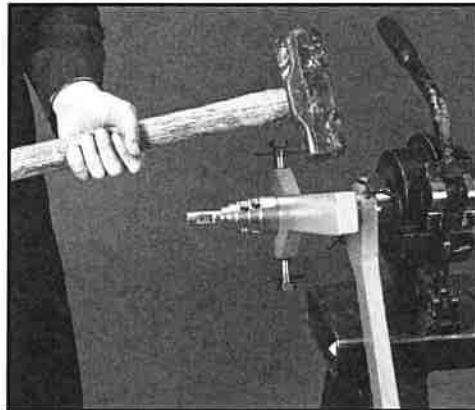

FIG. 35: TIGHTEN HEAD ASSEMBLY WITH BLOWS

Whip Hose & Control Assembly

3.

MAINTENANCE

Servicing the Whip Hose for 45-110 model tools

1. With tool fully assembled, put control stud into reverse position (see Fig. 36).
2. Using two wrenches remove the whip hose from the control stud (see Fig. 37).

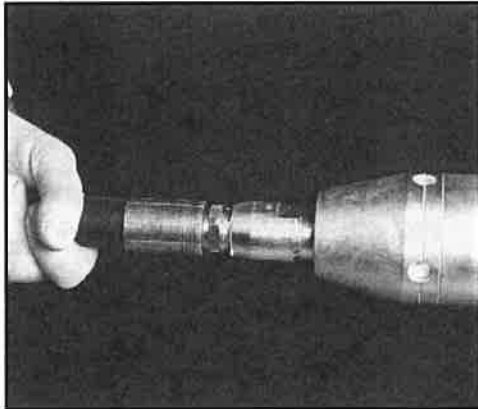

FIG. 36: PULL CONTROL STUD INTO REVERSE

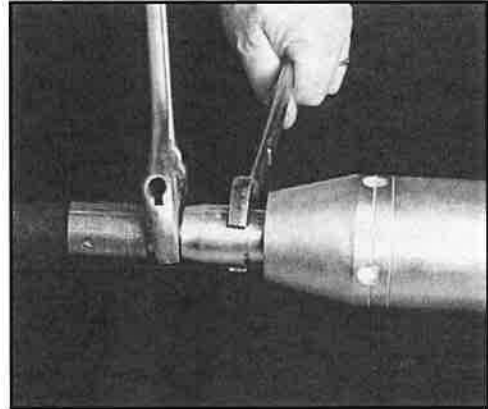

FIG. 37: REMOVE WHIP HOSE

3. Apply loctite 567 to the threads on the new whip hose and assemble (see Fig. 38).

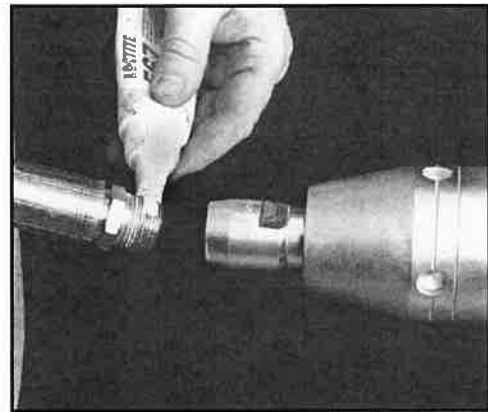

FIG. 38: APPLY LOCTITE 567 TO THREADS ON WHIP HOSE

Control Stud Disassembly for 45-110 model tools

1. Attach a spanner to the reverse cone, loosen with a large hammer (see Fig. 39) and take it off.
2. Pull out the control stud (see Fig. 40).

NOTE: If the control stud does not pull out easily, spray inside control stud casing with penetrating oil.

CAUTION

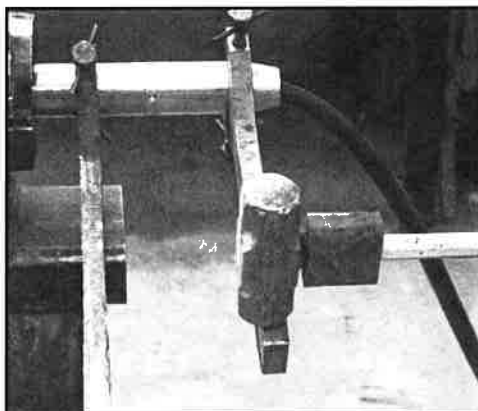

FIG. 39: LOOSEN REVERSE CONE

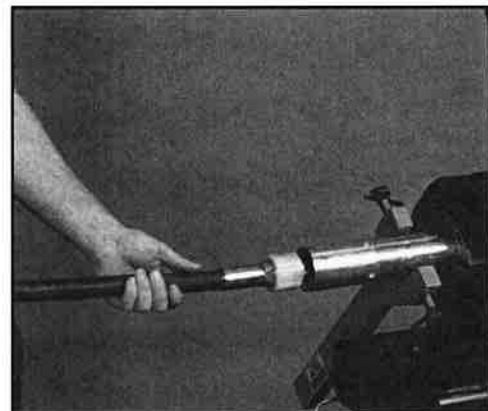

FIG. 40: REMOVE CONTROL STUD

3. Remove exhaust ring and inspect for damage or wear (see Fig. 41).
4. Clean and inspect control stud for damage or wear. If further disassembly is required, proceed as follows, otherwise follow control stud re-assembly directions on the next page.
5. Remove exhaust ring safety segment (see Fig. 42).

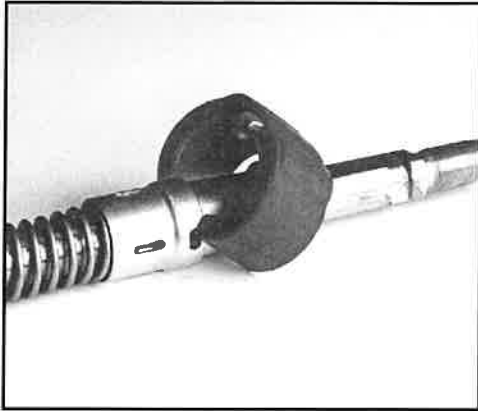

FIG. 41: REMOVE EXHAUST RING

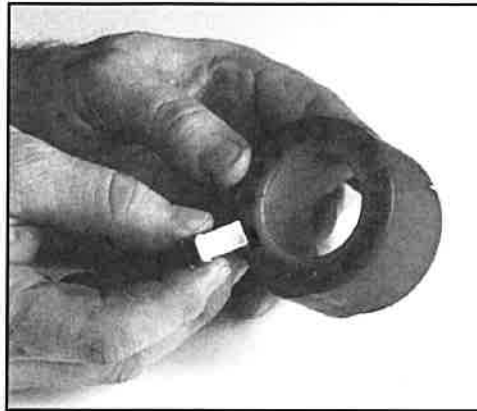

FIG. 42: REMOVE EXHAUST RING SAFETY SEGMENT

6. Apply heat to liquefy loctite holding the control stud adapter and remove (see Fig. 43).
7. Remove lockpiece bushing and spring: Release spring torque by compressing spring toward front of control stud until spring tab is exposed. Allow spring to unwind (one half to three quarters of a turn) (see Fig. 44). Twist the lockpiece bushing one quarter turn counter-clockwise to slide it off the control tube.
8. Remove spring.
9. Clean all parts and inspect for damage or wear. Replace if needed.

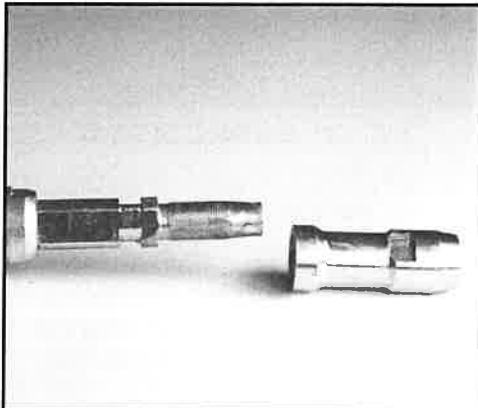

FIG. 43: REMOVE CONTROL STUD ADAPTER

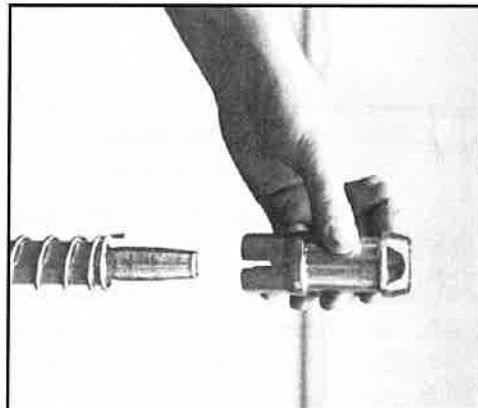

FIG. 44: REMOVE LOCK BUSHING AND SPRING

Control Stud Re-Assembly for 45-110 model tools

1. Cut the control seal off (see Fig. 45).
2. Replace seal, stretching the new seal to fit onto the stud (see Fig. 46), then re-form it with a special compression clamp (see Fig. 47).

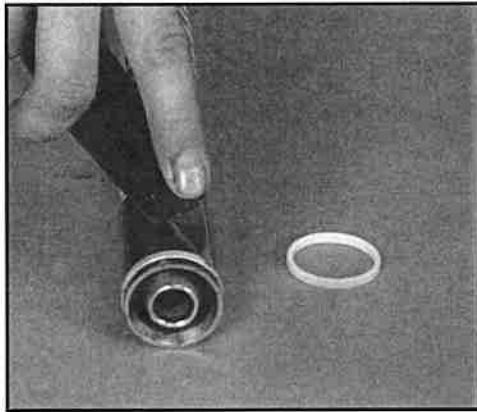

FIG. 45: REMOVE CONTROL SEAL

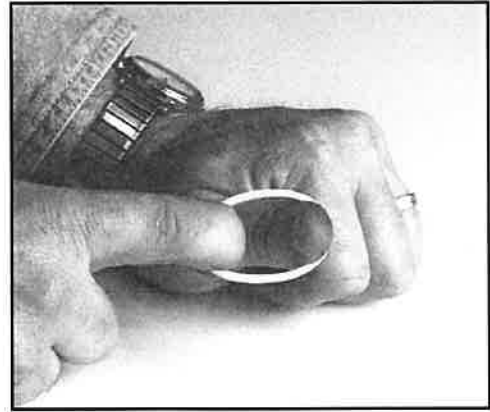

FIG. 46: STRETCH NEW SEAL TO FIT CONTROL STUD

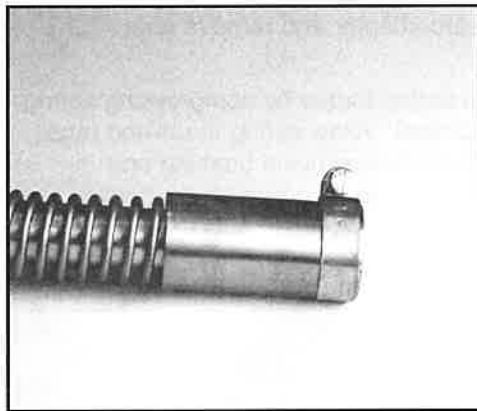

FIG. 47: REFORM WITH COMPRESSION CLAMP



FIG. 48: INSTALL SPRING

3. Install the spring onto the control stud, fitting the spring end into the hole inside the control liner (see Fig. 48).
4. Install the lock bushing, pushing it onto the control stud (see Fig. 49).
5. Pull back the spring and give it a counter-clockwise turn (from the front), at least half a turn, and then snap it into the nearest hole inside the lock bushing. This provides the torque for the operation of the control stud (see Fig. 50).

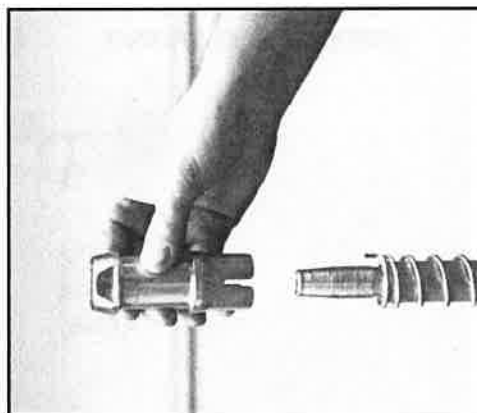

FIG. 49: INSTALL LOCK BUSHING



FIG. 50: TENSION SPRING

6. Test the operation of the lock bushing, making sure that the spring is sufficiently tensioned to snap the bushing back into position when released.
7. Fit exhaust ring onto control stud and install safety segment.
8. Apply Loctite 271 or 277 to the control stud adapter and tighten until it fits all the way onto the control stud (see Fig. 51).
9. Insert control stud into control stud housing, lining up the two indentations inside the control stud housing with the protrusions on the exhaust ring (see Fig. 52).

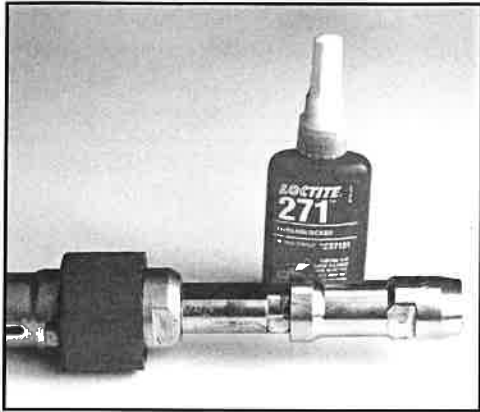

FIG. 51: APPLY LOCTITE AND TIGHTEN CONTROL STUD ADAPTER

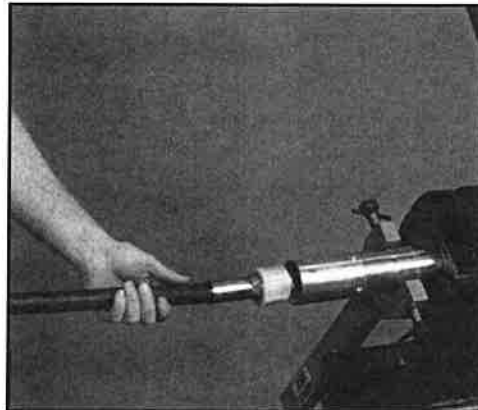

FIG. 52: INSERT CONTROL STUD

Servicing the Whip Hose for 130-180 model tools

1. Remove reverse cone or pipe pulling tail piece if needed, if the internal allen head screws cannot be reached.
2. Unscrew the 3 socket head cap screws of the hose connection using an allen wrench (see Fig. 53).
3. Use 2 socket head cap screws as jack screws to remove the whip hose (see Fig. 54).

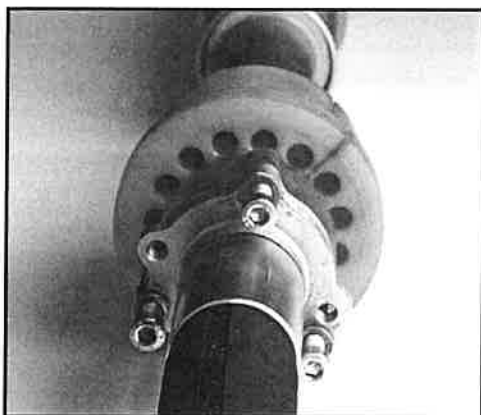

FIG. 53: REMOVE 3 SOCKET HEAD CAP SCREWS

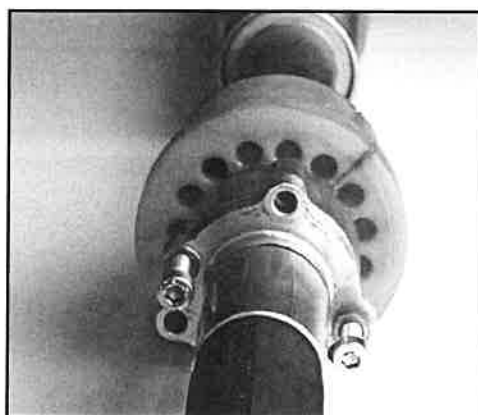

FIG. 54: 2 SCREWS USED AS JACK SCREWS

4. Remove the whip hose.
5. Unscrew the socket head cap screws from the threads.
6. Place o-ring in the groove of the hose connection, and whip hose if needed.
7. Place o-ring in the external groove of the hose connection.

8. Press the hose connection into the control tube in a way that the bores align with the threaded bores of the control tube.
9. Screw in the 3 socket head cap screws with lock washers and evenly tighten them using the allen wrench (see Fig. 55).
10. Reinstall the reverse cone or the pipe pulling tail piece if it had previously been removed.

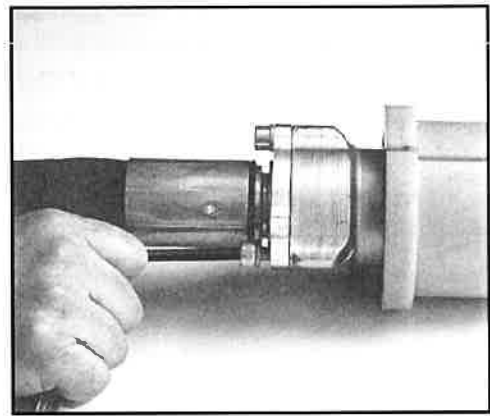

FIG. 55: TIGHTEN 3 SOCKET HEAD CAP SCREWS

Control Stud Disassembly for 130-180 model tools

1. Attach a spanner to the reverse cone, loosen with a large hammer and take it off.
2. Pull out the control stud.
3. Clamp the control stud into soft jaws of the vice with the whip hose pointing upwards, ready to be removed (see Fig. 56 and refer to appendix 2 for descriptions of parts).

IMPORTANT: Use a soft jaws adapter on the vice when clamping the control stud.

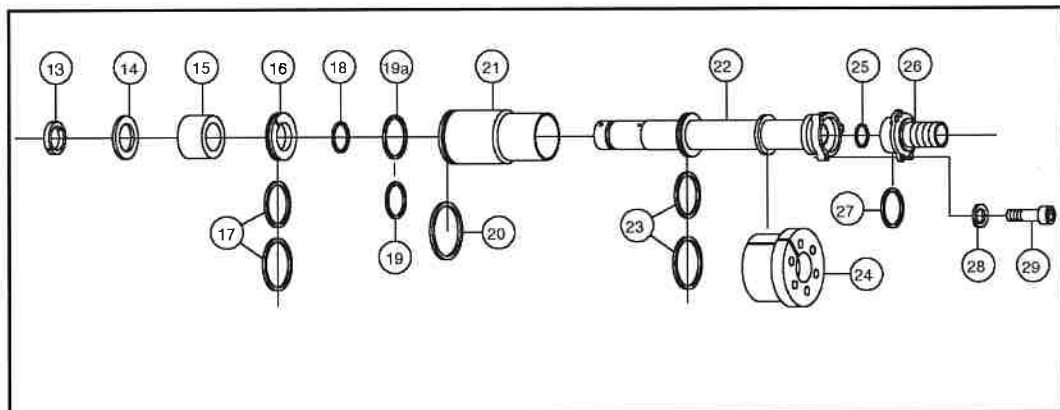

FIG. 56: CONTROL STUD COMPONENTS

4. Remove the whip hose by unscrewing the 3 socket head cap screws of the hose connection (see Fig. 57).
5. Use 2 socket head cap screws as jack screws to remove the whip hose (see Fig. 58).

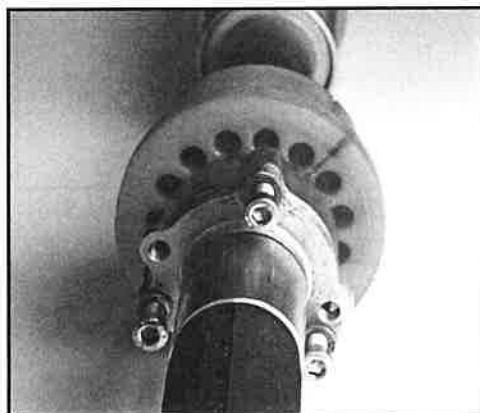

FIG. 57: REMOVE 3 SOCKET HEAD CAP SCREWS

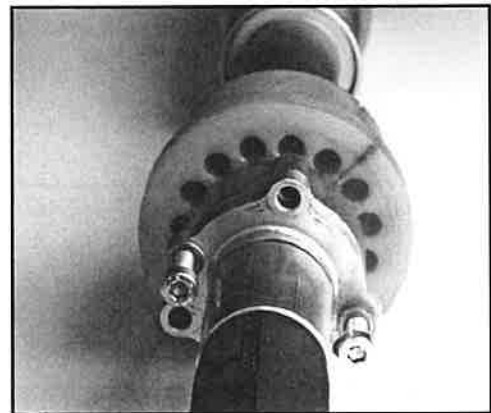

FIG. 58: 2 SCREWS USED AS JACK SCREWS

6. Pry open the elastic block and take it off the control stud (see Fig. 59).
7. Clamp the control stud into soft jaws of the vice with the control sleeve facing downwards.
8. Place the control tube end into the disassembly tool (see Fig. 60) until the bore of the tool overlaps the bores of the control tube.

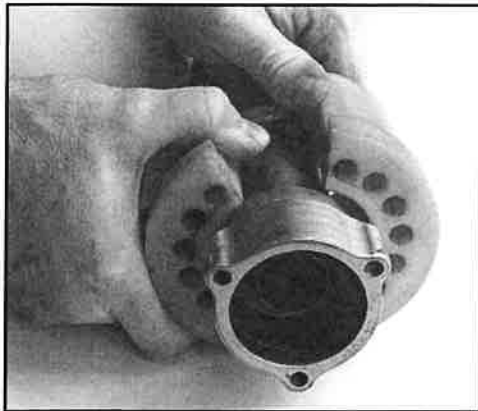

FIG. 59: REMOVE ELASTIC BLOCK

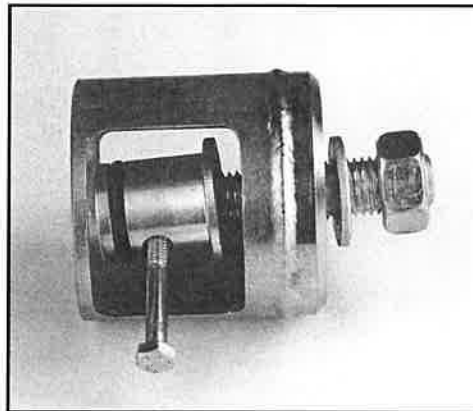
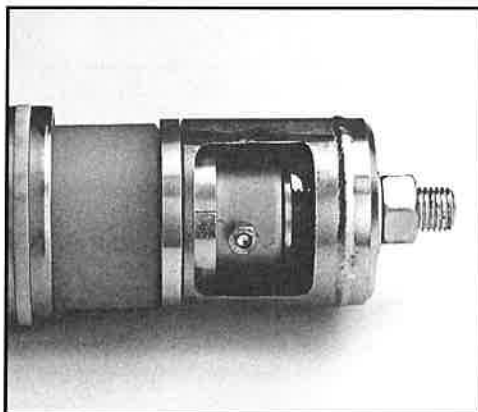
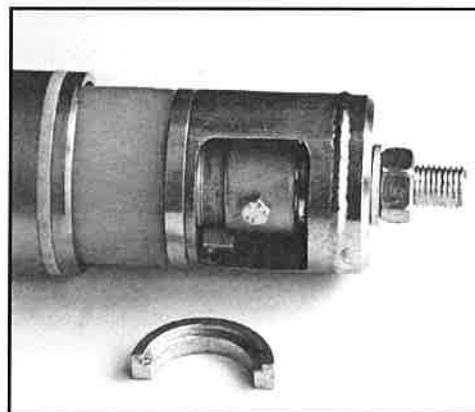

FIG. 60: DISASSEMBLY TOOL

9. Screw bolt into the bore. Secure the bolt with a nut to hold in place.
10. Place disassembly tool over the control tube end so that the disassembly tool sits on the support ring of the elastic block (see Fig. 61).
11. Tighten the screw of the control tube end so that the elastic block is compressed and both halves of the segmented rings can be taken out (see Fig. 62).



**FIG. 61: DISASSEMBLY TOOL
IN PLACE ON CONTROL TUBE**



**FIG. 62: REMOVE SEGMENTED
RINGS**

12. Take the segmented rings out of the groove of the control tube using a tool such as a screw driver.
13. Loosen the nut until the system has no tension.
14. Remove the bolt.
15. Loosen the nut and release the disassembly tool.
16. Take stop ring (number 16), and sealing ring (number 17) with the control tube off the control tube (see Fig. 56).
17. Remove all seals and o-rings, with an o-ring pick or some other tool.
18. Clean all components with solvent.

Control Stud Re-Assembly for 130-180 model tools

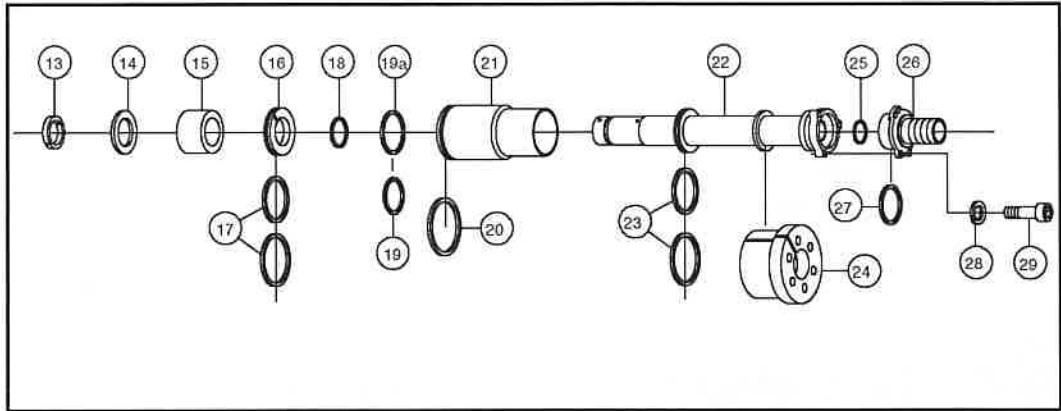

FIG. 63: CONTROL STUD COMPONENTS

1. Place the control sleeve seal into the groove of the control sleeve (see Fig. 63 and refer to appendix 2 for descriptions of parts).
2. Place the o-ring into the inner groove of the control sleeve and press it into place using a screw driver.
3. Place the control sleeve seal, with its special tool into the inner groove of the control sleeve in the shape of a kidney (see Fig. 64).
4. Place o-ring in the groove of the stop ring.
5. Place the o-ring of the seal kit into the external groove of the stop ring.
6. Carefully expand the cylindrical sealing ring of the seal kit.
7. Slip the sealing ring of the seal kit over the groove of the stop ring.
8. Use a hose compression clamp to compress the seal kit back into the original size. Remove the hose compression clamp.
9. Apply a thin layer of grease or lubricating oil over the sliding parts.
10. Place the control tube in the soft jaws of the vice on the work bench.
11. Slip the control sleeve over the control tube.
12. Place the stop ring with the lateral groove facing the control tube and into the control sleeve.
13. Slip the elastic block over the control tube.
14. Slip the support ring over the control tube.
15. Place the control tube end into the disassembly tool (see Fig. 65) until the bore of the tool overlaps the bores of the control tube.

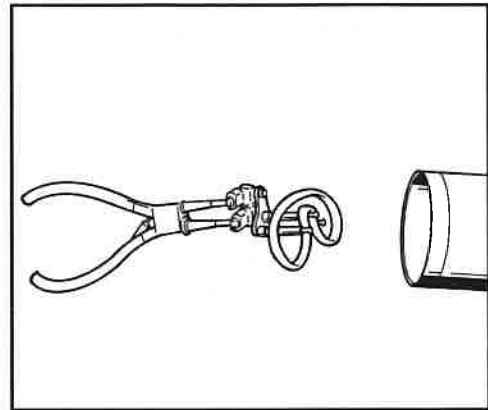

FIG. 64: INSTALLING CONTROL SLEEVE SEAL

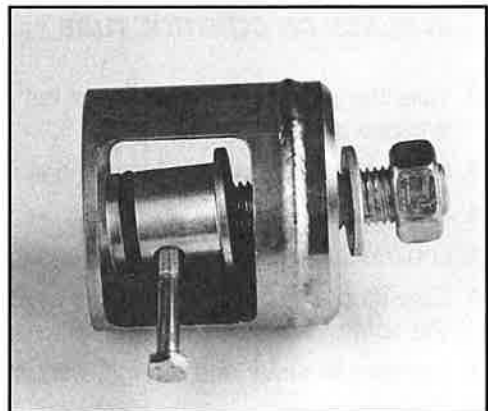

FIG. 65: DISASSEMBLY TOOL

16. Screw bolt into the bore. Secure the bolt with a nut to hold in place (see Fig. 66).
17. Turn the head of the screw so that it is at the edge of the disassembly tool.
18. Place disassembly tool over the control tube end so that the disassembly tool sits on the support ring of the elastic block.
19. Tighten the screw of the control tube end so that the elastic block is compressed and both halves of the segmented rings can be installed (see Fig. 67).

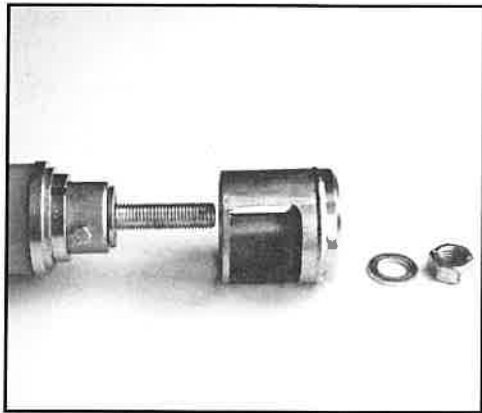
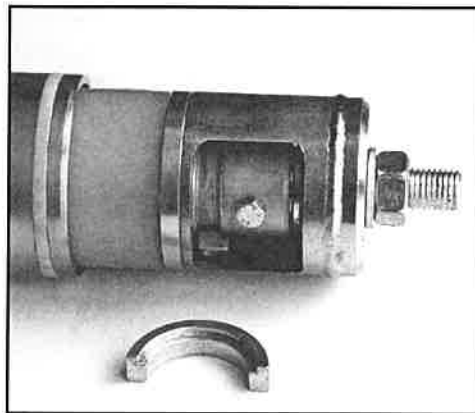
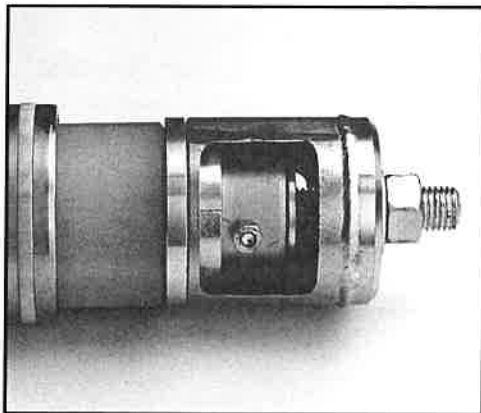

FIG. 66: SECURING BOLT

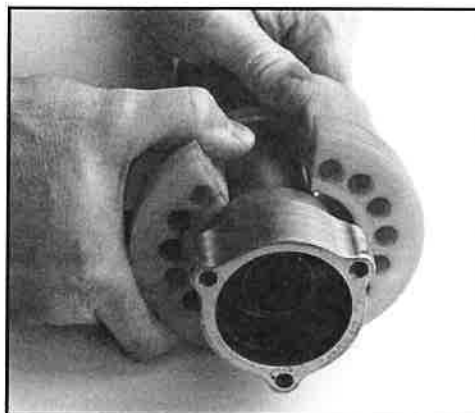

**FIG. 67: INSTALLING
SEGMENTED RINGS**

20. Use a screw driver to place the segmented rings into the groove of the control tube (see Fig. 68).
21. Unscrew the nut to release tension and then remove disassembly tool from the control tube end.
22. Release the screw and remove the control tube end out of the control tube.
23. Open the elastic block and place onto the control tube (see Fig. 69).



**FIG. 68: SEGMENTED RINGS
IN PLACE**



**FIG. 69: PLACING ELASTIC BLOCK
ON CONTROL TUBE**

Piston

4. MAINTENANCE

Piston Removal for All Tools

1. Secure the **GRUNDOMAT** in the **GRUNDOCLAMP** on the special repair stand.
2. Remove the add-on accessory (such as end cone), using spanner wrenches.
3. Pull the control stud out of the casing using the whip hose.
4. Use spanner wrenches and a hammer to loosen the rear screwing (see Fig. 70) (may need to heat to 400° F to liquefy loctite).
5. Place piston extractor hook in the bore of the piston, and extract the piston out of the casing (see Fig. 71).

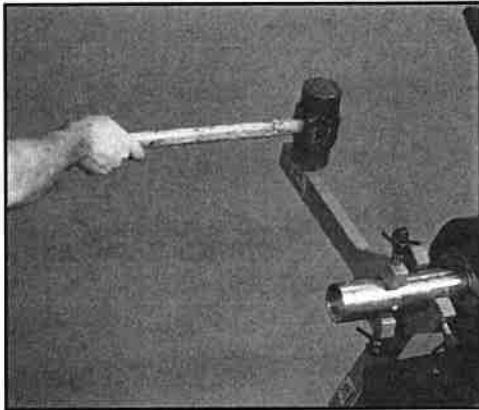

FIG. 70: REMOVE REAR SCREWING

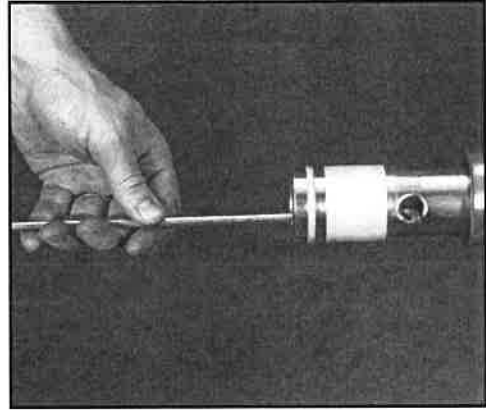

FIG. 71: REMOVE PISTON

Note: Lubricate the piston slides and seal with air tool oil during assembly.

Piston Assembly for All Tools

1. Position the front slide tape in the groove on the piston and begin to insert the piston (see Fig. 72).
2. Slide the piston in and position the rear slide tape (see Fig. 73).

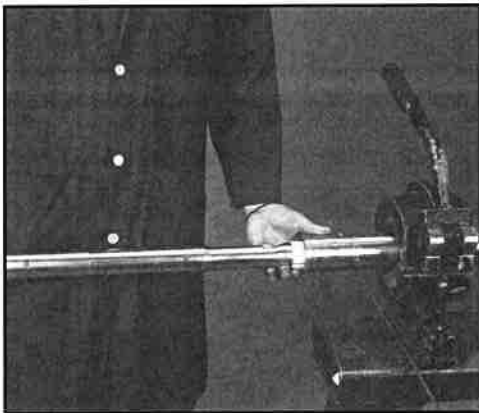

FIG. 72: INSERT PISTON

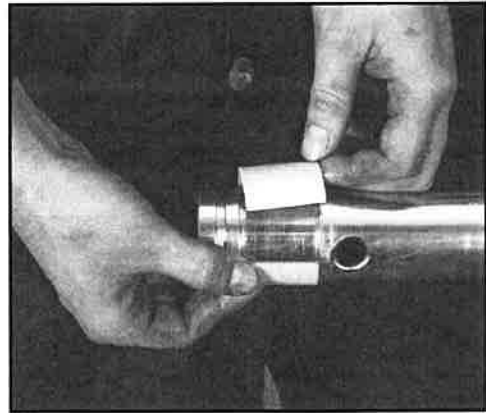

FIG. 73: POSITION REAR SLIDE TAPE

3. Make sure there is a gap of $\frac{1}{16}$ inch in the slide tapes (see Fig. 74).
4. Slide the piston in until only the small groove at the very rear of the piston remains in sight.

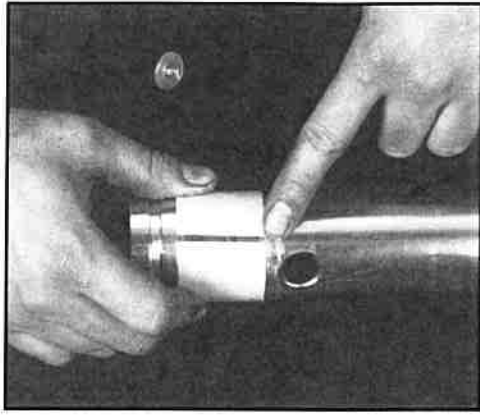

FIG. 74: SLIDE TAPE GAP

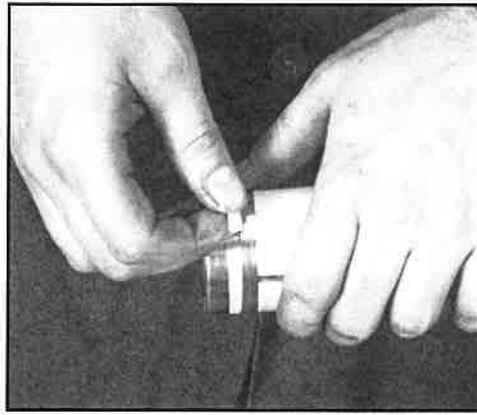

FIG. 75: INSERT THE PISTON SEAL

5. Install the piston seal into the groove. This seal is split (see Fig. 75).
6. Push the piston in all the way.
7. Make sure that the piston moves smoothly in the casing by pushing and pulling it several times with the piston hook.
8. Install control stud housing into casing using specified loctite product on the threads and tightening with a spanner wrench and hammer.
9. Insert control stud into housing, then install and tighten reverse cone or pipe pulling tailpiece using loctite 277 on the threads and tightening with a spanner wrench and hammer.

Function Test / Technical Information

After the assembly has been completed, the most important functions of the GRUNDOMAT should be tested:

Check the piston

- Lift the machine at its front and rear in order to find out whether the piston is able to reciprocate forward and backward.

Check functioning

- Attach an air hose and run the GRUNDOMAT briefly at low air pressure. Try the reverse function and then return to the forward function.

Break-In

- New seals require a short break-in period. Lay the tool on the ground and run at low pressure (30-40 psi) for about two minutes.



GRUNDOMAT Technical Information

Tool Size	45	55	65	75	85	95	100	110	130	145	160	180
Length (In)	36	44	48	58	59	63	67	73	69	78	79	87
Weight (Lbs)	19	31	55	70	101	150	154	215	258	370	437	573
Air Cons. (Cfm)	16	21	25	35	39	42	42	56	92	117	148	159
Air Press. (Psi)	95	95	95	95	95	95	95	95	95	95	95	95
Strokes / Min.	550	500	400	400	390	330	330	280	350	330	330	280

GRUNDOMAT Model P

(with push control stud, models 45-75)

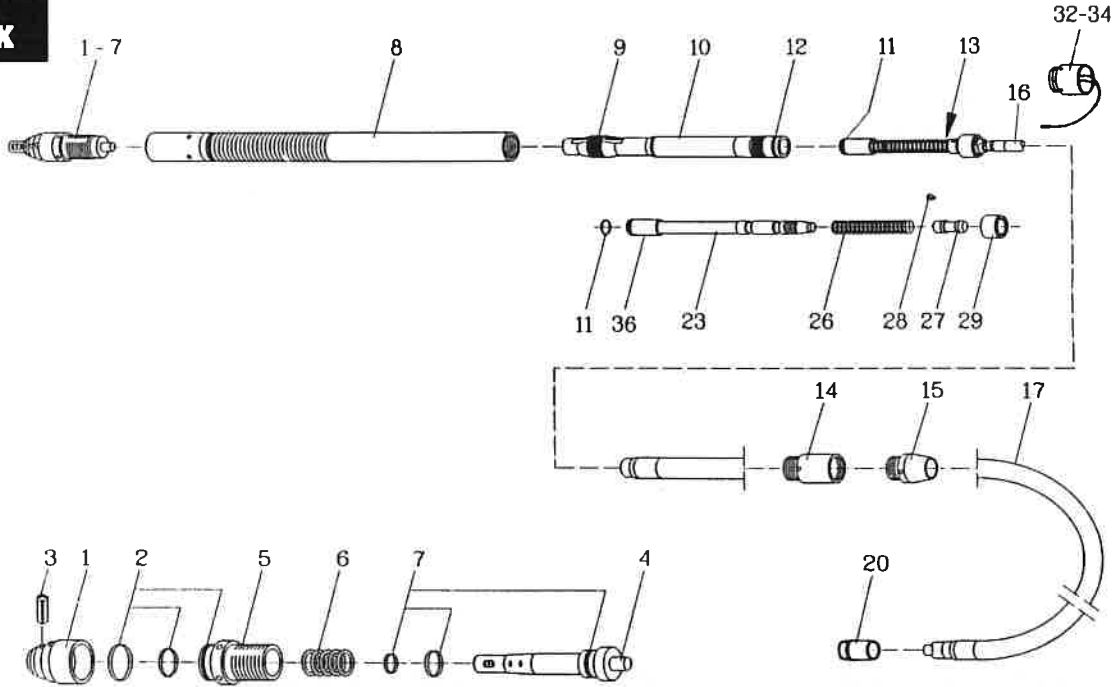

GRUNDOMAT Model			45P	55P	65P	75P
GRUNDOMAT Size			1.75"	2.00"	2.50"	3.00"
Ref.	Qty	Description	Part Number	Part Number	Part Number	Part Number
1	1	Stepped Cone	GE 045 5014	GP 055 5014	GP 065 5014	GP 075 5014
2	1	Stepped Cone Seal (set)*	YY 191648	GS 055 5030	GE 065 5030	GE 075 5030
3	1	Roll Pin Kit	GE 045 3020	GP 055 3020	GRU 065 3020	GE 075 3020
4	1	Chisel	GP 045 5062	GP 055 5062	GP 065 5062	GP 075 5062
5	1	Casing Tip	GE 045 5090	GP 055 5090	GP 065 5090	GP 075 5090
6	1	Chisel Spring	GE 045 5050	GP 055 5050	GRU 065 5050	GE 075 5050
7	1	Chisel Seal (set)*	GE 045 5080	GP 055 5080	GRU 065 5080	GE 075 5080
1-7	1	Casing Tip assembly, head stepped	GP 045 5514	GP 055 5514	GP 065 5514	GP 075 5514
8	1	Casing (Smooth)	GP 045 5122	GP 055 5122	GP 065 5122	GP 075 5122
9	1	Piston Slide Tapes (set)*	GE 045 5130	GS 055 5130	GP 065 5130	GP 075 5130
10	1	Piston	GE 045 5141	GS 055 5141	GP 065 5141	GP 075 5141
11	1	Control Stud Seal	YY 191605	YY 191679	YY 191608	YY 191636
12	1	Piston Seal*	YY 191607	YY 191678	YY 192129	YY 192128
13	1	Control Stud with connection air hose (Items 11, 16, 17, 20, 23-29)	GS 045 8004	GP 055 8004	GS 065 8004	GS 075 8004
14	1	Control Stud Housing	GS 045 6460	GS 055 6460	GZ 065 6460	GZ 075 6460
15	1	Reverse Cone	GE 045 6450	GS 055 6450	GE 065 6450	GZ 075 6450
16	1	Control Stud Adapter	YY 081716	YY 081716	YY 031708	YY 051708
17	1	Connection Air Hose, Complete	07022720	07022720	07022731	07022731
20	1	Cap	GE 045 2390	GE 045 2390	GE 090 2390	GE 090 2390
11, 23	1	Control Pipe and Liner	GS 045 8040	GS 055 8040	GS 065 8040	GS 075 8040
26	1	Spring	YY 081707	YY 300115	YY 031707	YY 051707
27	1	Lock Sleeve	GS 045 8055	GS 055 8055	GS 065 8055	GS 075 8055
28	1	Safety Segment	YY 081705	YY 301705	YY 031705	YY 051705
29	1	Elastic Block	GP 045 8025	GP 055 8025	GZ 065 8025	GZ 075 8025
32-34	1	Pipe Pulling Tail Piece (Optional)	N/A	N/A	N/A	GZ 075 0300
36	1	Control Liner w/Bushing	GS 045 8042	GS 055 8042	GS 065 8042	GS 075 8042
		Complete Seal Kit (Items # 2, 7, 9, 11, 12, seal for female coupling)	GS 045 6320	GP 055 6320	GP 065 6320	GP 075 6320

*Included in Complete Seal Kit above.

GRUNDOMAT Model P

(with push control stud, models 85-100)

2.

APPENDIX

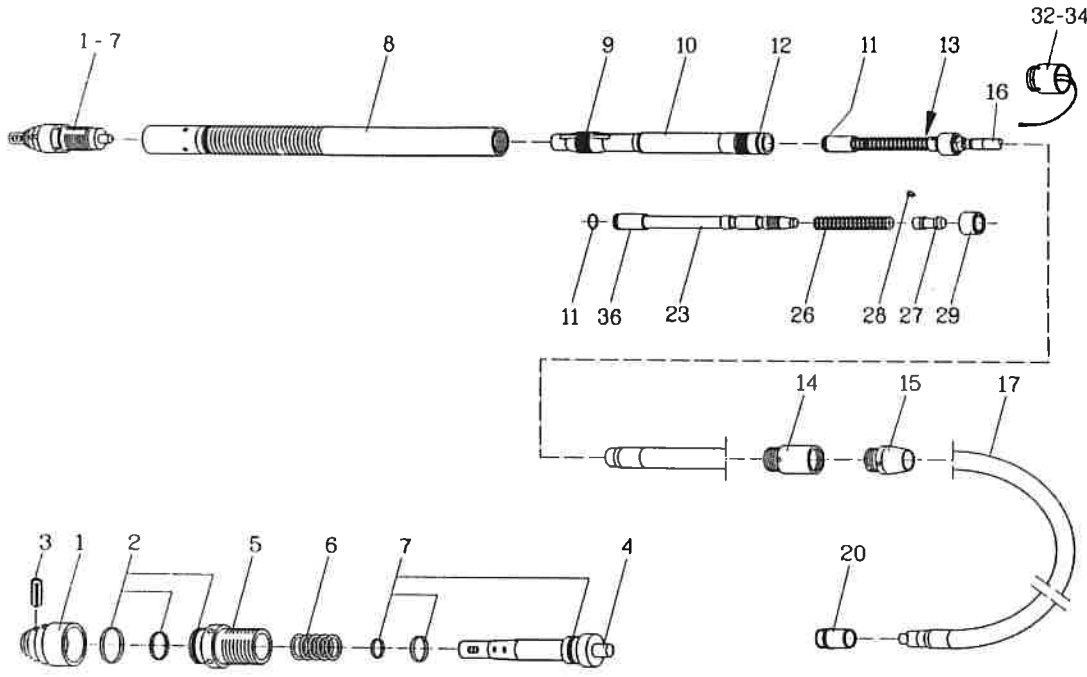

GRUNDOMAT Model			85P	95P	100P	100PK
GRUNDOMAT Size			3.33"	3.75"	4.00"	4.00"
Ref.	Qty	Description	Part Number	Part Number	Part Number	Part Number
1	1	Stepped Cone	GP 085 5014	GP 095 5014	GP 095 5018	—
2	1	Stepped Cone Seal (set)*	GZ 085 5030	GE 090 5030	GE 095 5030	—
3	1	Roll Pin Kit	GZ 085 3020	GRU 095 3020	GRU 095 3020	—
4	1	Chisel	GP 085 5062	GP 095 5062	GP 095 5062	—
5	1	Casing Tip	GP 085 5090	GP 095 5090	GP 095 5090	—
6	1	Chisel Spring	GZ 085 5050	GE 090 5050	GE 090 5050	—
7	1	Chisel Seal (set)*	GZ 085 5080	GE 090 5080	GE 090 5080	—
1-7	1	Casing Tip assembly, head stepped	GP 085 5514	GP 095 5514	GP 095 5518	—
8	1	Casing (Smooth)	GP 085 5122	GP 095 5122	GP 100 5122	YY 025292 w/head
9	1	Piston Slide Tapes (set)*	GZ 085 5130	GP 095 5130	GP 095 5130	GP 095 5130
10	1	Piston	GZ 085 5141	GP 095 5141	GP 095 5141	GKP 095 5141
11	1	Control Stud Seal	YY 191692	YY 191619	YY 191619	YY 191619
12	1	Piston Seal*	YY 191690	YY 192122	YY 192122	YY 192122
13	1	Control Stud w/connection air hose (Items 11, 16, 17, 20, 23-29)	GS 085 8004	GS 095 8004	GS 095 8004	GS 095 8000
14	1	Control Stud Housing	GZ 085 6460	GP 095 6460	GP 095 6460	GKP 100 6460
15	1	Reverse Cone	GZ 085 6450	GE 095 6450	GE 095 6450	YY 025288
16	1	Hose Nut Adapter	YY 021712	YY 021712	YY 021712	YY 021712
17	1	Connection Air Hose, Complete	07022740	07022740	07022740	07022740
20	1	Cap	GE 090 2390	GE 090 2390	GE 090 2390	GE 090 2390
11, 23	1	Control Pipe and Liner	GS 085 8040	GS 095 8040	GS 095 8040	GS 095 8040
26	1	Spring	YY 311707	YY 021707	YY 021707	YY 021707
27	1	Lock Sleeve	GS 085 8055	GS 095 8055	GS 095 8055	GS 095 8055
28	1	Safety Segment	YY 051705	YY 021705	YY 021705	YY 021705
29	1	Elastic Block	GZ 085 8025	GZ 095 8025	GZ 095 8025	GZ 095 8025
32-34	1	Pipe Pulling Tail Piece (Optional)	GZ 085 0300	GE 095 0300	GE 095 0300	—
36	1	Control Liner w/Bushing	GS 085 8042	GS 095 8042	GS 095 8042	GS 095 8042
		Complete Seal Kit (Items # 2, 7, 9, 11, 12, seal for female coupling)	GS 085 6320	GP 095 6320	GP 095 6320	—

*Included in Complete Seal Kit above.

GRUNDOMAT Model P

(with push control stud, model 110-130)

3. APPENDIX

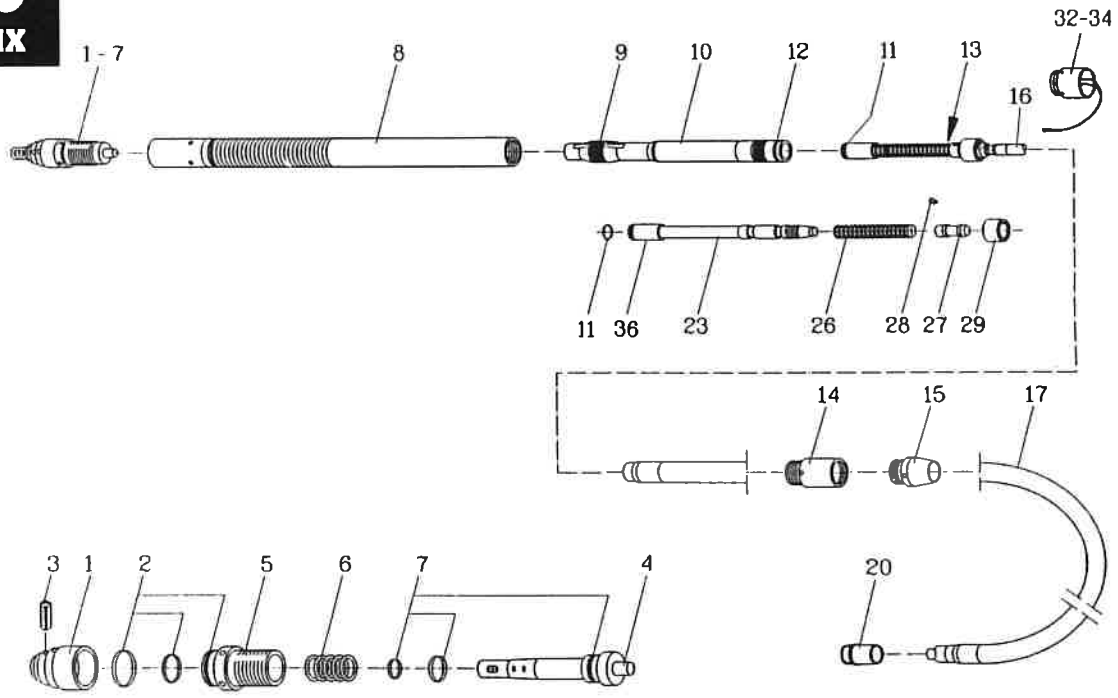

GRUNDOMAT Model			110P	130P 1/4 Turn
GRUNDOMAT Size			4.25"	5.00"
Ref.	Qty	Description	Part Number	Part Number
1	1	Stepped Cone	GP 110 5014	GP 130 5014
2	1	Stepped Cone Seal (set)*	GE 110 5030	GE 130 5030
3	1	Roll Pin Kit	GE 110 3020	GRU 130 3020
4	1	Chisel	GP 110 5062	GP 130 5062
5	1	Casing Tip	GE 110 5090	GP 130 5090
6	1	Chisel Spring	GE 110 5050	GRU 130 5050
7	1	Chisel Seal (set)*	GE 110 5080	GRU 130 5080
1-7	1	Casing Tip assembly, head stepped	GP 110 5514	GP 130 5514
8	1	Casing (Smooth)	GP 110 5122	GP 130 5122
9	1	Piston Slide Tapes (set)*	GP 110 5130	GE 145 5130
10	1	Piston	GP 110 5141	GP 130 5141
11	1	Control Stud Seal	YY 192510	YY 192068
12	1	Piston Seal*	YY 192508	YY 191628
13	1	Control Stud with connection air hose (Items 11, 16, 17, 20, 23-29)	GP 110 8004	GS 130 8004
14	1	Control Stud Housing	GP 110 6460	GP 130 6460
15	1	Reverse Cone	GE 110 6450	GE 130 6450
16	1	Hose Nut Adapter	YY 091712	YY 061715
17	1	Connection Air Hose, Complete	07022740	07022751
20	1	Cap	GE 090 2390	GRU 200 6641
11, 23	1	Control Pipe and Liner	GP 110 8040	GS 130 8006
26	1	Spring	1401050004	YY 061712
27	1	Lock Sleeve	GS 110 8055	GS 130 8056
28	1	Safety Segment	YY 091705	YY 061716
29	1	Elastic Block	GZ 110 8025	GV 130 8025
32-34	1	Pipe Pulling Tail Piece (Optional)	GE 110 0300	GE 130 0300
36	1	Control Liner w/Bushing	GP 110 8042	GS 130 8046 + YY 061703
		Complete Seal Kit (Items # 2, 7, 9, 11, 12, seal for female coupling)	GP 110 6320	GV 130 6320

*Included in Complete Seal Kit above.

GRUNDOMAT Model P

(with air operated control stud, models 130-180)

4.

APPENDIX

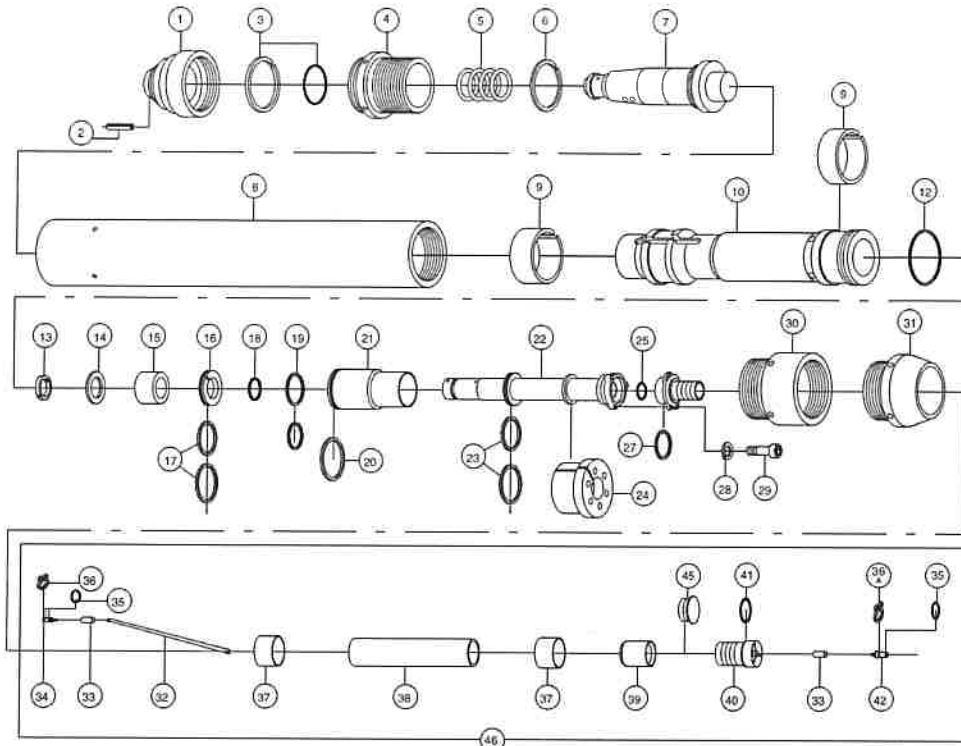

GRUNDOMAT Model GRUNDOMAT Size			130P 5.00"	145P 5.75"	160P 6.25"	180P 7.00"
Ref.	Qty	Description	Part Number	Part Number	Part Number	Part Number
1	1	Stepped Cone	GP 130 5014	GP 145 5014	GP 160 5014	GP 180 5014
2	1	Roll Pin Kit	GRU 130 3020	GE 145 3020	GP 160 3020	GP 180 3020
3	1	Stepped Cone Seal (set)*	GE 130 5030	GE 145 5030	GF 160 5030	GE 180 5030
4	1	Casing Tip	GRU 130 5090	GP 145 5090	GP 160 5090	GE 180 5090
5	1	Chisel Spring	GRU 130 5050	GE 145 5050	GP 160 5050	GE 180 5050
6	1	Chisel Seal (set)*	GRU 130 5080	GE 145 5080	GP 160 5080	H 220 0107
7	1	Chisel	GP 130 5062	GP 145 5062	GP 160 5062	GP 180 5062
1-7	1	Casing Tip assembly, head stepped	GP 130 5514	GP 145 5514	GP 160 5514	GP 180 5514
8	1	Casing (Smooth)	GP 130 5122	GP 145 5122	GP 160 5122	GP 180 5122
9	1	Piston Slide Tapes (set)*	GE 145 5130	GP 145 5130	GP 160 5130	GP 180 5130
10	1	Piston	GP 130 5141	GP 145 5141	GP 160 5141	GP 180 5141
12	1	Piston Seal*	YY 191628	YY 192114	GP 160 5160	GP 180 5160
-	1	Control Stud with connection air hose (Items 13-24, 25-29, 32-45)	GV 130 8000	GV 145 8000	GV 160 8000	GV 180 8000
13	1	Segment Ring	YY 140920	YY 140920	YY 140920	YY 150921
14	1	Support Ring for Elastic Block	YY 140919	YY 140919	YY 140919	YY 150920
15	1	Elastic Block for Control Sleeve	GV 130 8043	GV 160 8043	GV 160 8043	GV 180 8043
16	1	Stop Ring	YY 060998	YY 070917	YY 140917	YY 150918
17	1	Seal for Control Sleeve 1 (set)*	GV 130 8075	GV 145 8075	GV 160 8075	GV 180 8075
18	1	O-Ring	21252564	21252564	21252564	21253037
19	1	Seal for Control Tube (set)*	GV 130 8070	GV 130 8070	GV 160 8070	GV 180 8070
20	1	Seal for Control Sleeve (exterior)*	YY 192068	YY 192112	YY 192121	YY 192113
21	1	Control Sleeve	YY 060977	YY 070916	YY 140916	YY 150917
22	1	Control Tube	YY 060997	YY 070915	YY 140915	YY 150915
23	1	Seal for Control Sleeve 2 (set)*	GV 130 8080	GV 145 8080	GV 160 8080	GV 180 8080
24	1	Elastic Block for Air-Operated Control Stud	GV 130 8025	GV 145 8025	GV 160 8025	GV 180 8025
25	1	O-Ring	21252071	21252071	21252071	21252499
27	1	O-Ring	21252943	21252943	21252943	21253393
28	3	Lock Washer	180127012024	180127012024	180127012024	180127012027
29	3	Socket Head Cap Screw	180912512137	180912512138	180912512138	180912512178
30	1	Control Stud Housing	GP 130 6460	GP 145 6460	GP 160 6460	GP 180 6460
31	1	Reverse Cone	GE 130 6450	GE 145 6450	GF 160 6450	GE 180 6450
w/o ill.	1	Pipe Pulling Tail Piece	GE 130 0300	GE 145 0300	GF 160 0300	GE 180 0300
35	1	O-Ring	21250387	21250387	21250387	21250387
36	1	Securing Ring	180471010009	180471010009	180471010009	180471010009
36 A	1	Securing Ring	180471010012	180471010012	180471010012	180471010012
41	1	O-Ring	21252206	21252740	21252740	21252740
45	1	Dirt Plug	YY 060988	YY 150935	YY 150935	YY 150935
46	1	Connection Air Hose, Complete (Items 25-29, 32-45)	GV 130 8110	GV 160 8110	GV 160 8110	GV 180 8110
	1	Complete Seal Kit (Items # 3, 6, 9, 12, 17, 19, 20, & 23)	GV 130 6320	GV 145 6320	GV 160 6320	GV 180 6320

*Included in Complete Seal Kit above.

Control Unit/Lubricator (with air operated control stud)

5. APPENDIX

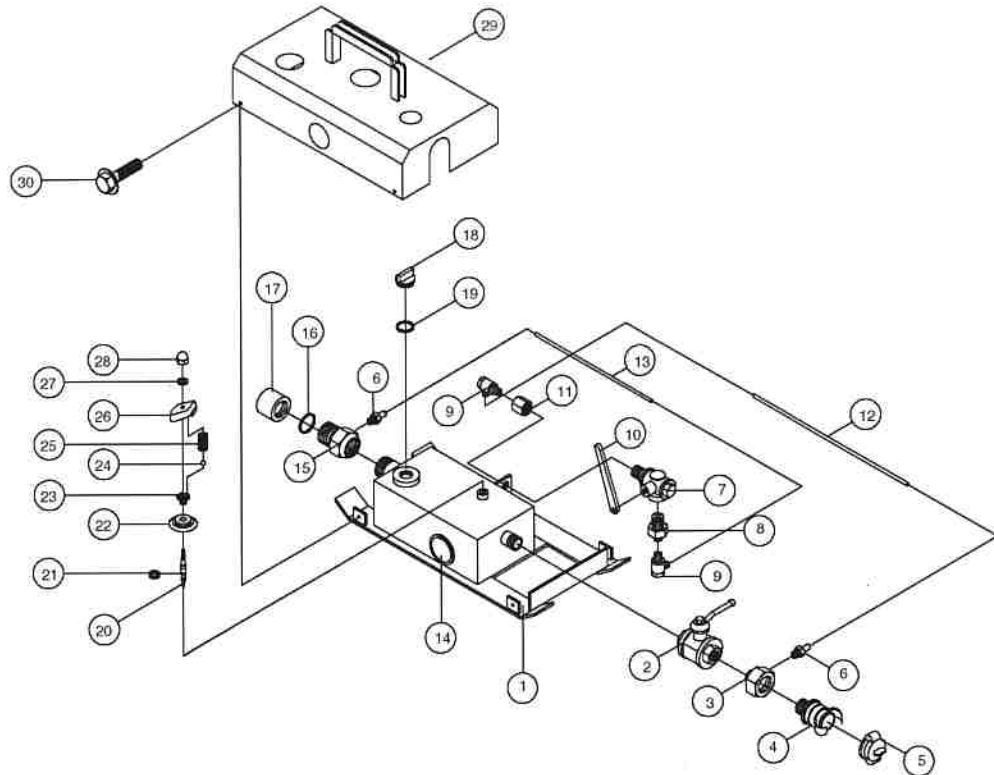

Control Unit/Lubricator for Air-Operated Control Stud Models			3 Quart Lubricator, 1" Airline (130 P)	1 Gallon Lubricator, 1 3/8" Airline (145-180 P)
Ref.	Qty	Description	Part Number	Part Number
-	1	Complete Control Unit (Items 1-29)	GV 130 2300	GV 180 2300
1	1	Control Unit	YY 060948	YY 150952
2	1	Ball Valve with Handle	1655016	1655067
3	1	Adapter	YY 060952	YY 150945
4	1	Coupling	GRU 200 2600	-
5	1	Locking Coupling	GRU 200 2060	G 260 0221
6	2	Nipple	1641098	1641098
7	1	3-Way Ball Valve	1655056	1655056
8	1	Reduction Nipple	1641099	1641099
9	2	Fitting	2076010090	2076010090
10	1	Handle for Ball Valve	YY 060962	YY 061134
11	1	Screwing	2024010010	2024010010
12	1	Control Hose 400 long (without screwing)	YY 061125	YY 150973
13	1	Control Hose 300 long (without screwing)	YY 061124	YY 150972
14	1	Oil Level Indicator	1602105	1602105
15	1	Connection Nipple for Control Unit	YY 060951	YY 150957
16	1	O-Ring	21252206	21252740
17	1	Lock Nut for Hose Nipple	YY 060987	YY 150936
18-19	1	Lock Screw	GRU 200 3155	GRU 200 3155
19	1	O-Ring for Lock Screw	21251866	21251866
20	1	Oil Regulating Screw	YY 220126	YY 220126
21	1	O-Ring for Oil Regulating Screw	21250341	21250341
22	1	Adjustment Knob	YY 220128	YY 220128
23	1	Lock Sleeve	YY 220130	YY 220130
24-25	1	Spring with Steel Ball	GRU 200 3130	GRU 200 3130
26-28	1	Turn Knob with Screw and Cap Nut	GRU 200 3140	GRU 200 3140
29	1	Cover, Complete	YY 060942	YY 150942
30	4	Hexagon Screw	186921512056	186921512056

GRUNDOMAT Service Tools & Accessories



Spanner Wrenches

Part Number	Tool Model
07033215	45
07033220	55
07033225	65
07033230	75
07033237	85, 95
07033240	100, 110
07033250	130
07033257	145
07033270	180

Control Stud Assembly Tool

Part Number	Tool Model
YY 060 931	130, 145, & 160
YY 150 958	180

Chisel Protection Sleeve

Part Number	Tool Model
GE 045 3640	45
GS 055 3640	55
GRU 065 3640	65
GRU 075 3640	75
GZ 085 3640	85
GRU 095 3640	95
GE 110 3640	110
GRU 130 3640	130
GE 145 3640	145

Seal Compression Clamps

Part Number	Tool Model
1625002	45, 55
1625003	65
1625013	75, 85
1625021	95, 100
1625007	110
1625009	130

Replacement

Roll-Pin Punches

Part Number	Size (mm)	Tool Model
220410050	9	45
220410007	7	55
220410060	11	65
220410090	13	75
220410080	15	85, 95, 100
220410110	17	110
220410111	19	130
220410135	23	145

Air Hoses

Part Number	Description	Tool Model
07020117	1/2" x 50'	45-55
07020135	3/4" x 50'	65-110
GV 130 2257	1" x 65'	130
GV 180 2257	1 3/8" x 65'	145-180

Stepped Cone Removal Ring

Part Number	Tool Model
GS 055 3450	45-55
GE 095 3450	65-95
GE 145 3450	110-145

Lubricators

Part Number	Tool Model
07022917	45-55
07022935 or GRU 200 2298	65-110
GV 130 2300 or GRU 200 2296	130
GV 180 2300	145-180

Air Tool Oil

Part Number	Description
07023115	GRUNDO-OIL All Season Biodegradable, 1 gallon
07023112	55 gallon drum

Videos

Go to:
<http://www.tttechnologies.com/videos-animations/>

Trouble Shooting

Trouble Shooting Guide		
Observation	Reason	Solution
1. The general bore speed of the GRUNDOMAT decreases during the bore.	<p>a) The compressor no longer produces the required pressure.</p> <p>b) Air leakage caused by defective or missing seals on the hose couplings.</p> <p>c) The lubrication of the GRUNDOMAT is insufficient</p> <p>d) Freezing! Due to rapid expansion of the already compressed air, below 40° F ambient air temperatures, the compressed air cools down to a point where the soil around the GRUNDOMAT freezes and forms a solid layer of ice on the outside of the machine casing. This combined effect of the ground and machine freezing stops further soil displacement and the GRUNDOMAT stops.</p> <p>e) When directly pulling pipes, shrinking or contracting soils may lead to increased friction on the pipe. This happens when the pipe is already too tight in the bore or the bore hole diameter isn't large enough for the pipe.</p>	<p>a) The optimum air pressure is 90 psi. This may be increased to counter the pressure drop if several long air hoses are used on a long bore.</p> <p>b) If necessary, replace the seals.</p> <p>c) Check the oil level (on the indicator of the control unit). Check to make sure the right type of oil is being used. In winter, use oils (GRUNDO-OIL) with anti-freeze properties.</p> <p>d) Use a compressed air heater UNITHERM / MAXITHERM which pre-warms the compressed air before entering the GRUNDOMAT.</p> <p>e) Use smaller diameter, smooth pipes or a larger GRUNDOMAT. The outer diameter of the pipe being installed should be at least 10% smaller in diameter than the GRUNDOMAT tool. Apply Bentonite or Polymer to pipe outside diameter to reduce surface friction.</p>
2. GRUNDOMAT begins normally, about half way into the ground, the bore speed is slowly reduced until the machine comes to a standstill.	<p>a) The friction increases as the soil is sticky and shrinking. The machine is being held tight and forward speed is reduced.</p>	<p>a) Back the GRUNDOMAT out and fit an oversized multi-cutter cone on the front of the tool.</p>
3. The general impact energy of the GRUNDOMAT decreases.	<p>a) The control stud and piston seals are damaged or missing.</p> <p>b) The multi-cutter cone does not move forward or backward.</p>	<p>a) Replace the seals.</p> <p>b) Disassemble the multi-cutter cone, clean it and assemble with new seals; if the spring is worn or broken, replace it.</p>

Trouble Shooting

Trouble Shooting Guide		
Observation	Reason	Solution
4. The general impact energy of the GRUNDOMAT decreases.	<ul style="list-style-type: none"> c) The lubrication of GRUNDOMAT is insufficient. d) The control stud and piston are sticking (not moving freely). e) Incorrect oil/lubricant has been used (such as hydraulic oils or ATF). 	<ul style="list-style-type: none"> c) Check the oil level on the control unit. If necessary increase the oil volume on the control unit. d) Pour some GRUNDO-OIL into the air hose and flush tool. e) The oil has turned into resin on the inner components of the machine; disassemble the machine and clean its components.
5. The GRUNDOMAT does not arrive direct on target in the exit pit.	<ul style="list-style-type: none"> a) When looking through the bore, it is straight; therefore the initial alignment was not correct. b) The GRUNDOMAT has started to "swim" in soft soil. c) The bore speed was in excess of 65 feet per hour causing it to deviate from its path. d) The GRUNDOMAT was not fitted with the right displacement head. e) The multi-cutter cone is badly worn. 	<ul style="list-style-type: none"> a) Take better care during the alignment of the machine. Make use of the starting cradle and GRUNDOSCOPE aiming frame and check them. b) Reduce the air supply via the ball valve on the control unit. Statically push the pipes using a winch as the soil friction is insufficient and the machine starts to "swim". c) Reduce the air supply, slightly close the ball valve on the control unit. d) In rocky soil, use the stepped multi-cutter cone; in sandy soils, use the threaded or slip on smooth cone. e) Replace the multicutter cone with a new one.

Trouble Shooting

Trouble Shooting Guide		
Observation	Reason	Solution
6. Reversing from forward to backward motion is a problem.	a) The control mechanism is dirty or defective.	a) Check if parts on the control stud have worn and clean or replace them if necessary.
7. When switching the GRUNDOMAT 145 P tool from forward to reverse the machine makes another 5 to 6 strokes, then comes to a standstill.	a) The GRUNDOMAT tool does not have sufficient friction in reverse, the machine "swims".	a) When switching the machine into reverse, reduce the air supply temporarily using the stop cock on the auto reverse control system.
8. GRUNDOMAT switches into reverse even though the handle on the control unit is in forward position (Models 130-180 P Tools).	<p>In forward motion the control hose is not pressurized. If the control hose or the seal (described below) are defective, the GRUNDOMAT will automatically run backward. Also if excessive air escapes from the 3-way ball valve.</p> <p>a) The o-rings in the control hose couplings are defective or missing.</p> <p>b) The control hose coupling is defective.</p> <p>c) The TT coupling on the connection hose, the air hose, the control unit or the bypass are not tightened securely.</p> <p>d) The control hose is defective.</p> <p>e) The o-ring in the whip hose is defective or missing (Item 25, pg 34).</p> <p>f) The seal in the control sleeve is defective (Item 19, pg 34).</p> <p>g) Seals of the stop ring are defective.</p> <p>h) The control hose is loose.</p>	<p>a) Change the o-rings.</p> <p>b) Check the control hose coupling and replace it, if necessary.</p> <p>c) Thread manually until the very end.</p> <p>d) Replace the control hose.</p> <p>e) Replace the o-ring.</p> <p>f) Replace the seal.</p> <p>g) Replace the seals.</p> <p>h) Lay out the hose & reconnect it.</p>

Get to Know the Mole



Additional products and training materials are also available, like our Tools & Accessories Catalogs and User Manuals, Contact your TT salesman for details.

All rights reserved. No part of this catalog may be reproduced or transmitted in any form or by any means, electronic or mechanical, including storage on an information retrieval system, without written permission from TT TECHNOLOGIES, Inc.

Your One Source

FOR TRENCHLESS INFORMATION:



www.tttechnologies.com



TT Technologies, Inc.

2020 E New York Street • Aurora, IL 60502 • 800-533-2078 • 630-851-8200 • FAX 630-851-8299

www.tttechnologies.com • E-mail info@tttechnologies.com

Printed in USA • 01.01.18 • REV 4.1
Copyright© 2018, TT Technologies, Inc.